

都汇里

HC28 COSMO

HOME COLLECTION

The ultimate pursuit is  
a better self with the life of your dreams.

在未来，更好的自己、理想中的生活才是人们的终极向往。



都汇里，用“简约”的语言，重塑“奢华”的维度，与众多国际设计大师 Christophe Delcourt, Yonoh, 梁志天 Steve Leung 和 Roderick Vos 等，创造出高级有机，时尚有趣和优雅大气的现代家具系列，并以突破性的视角和国际化水准的精湛工艺，诠释高级奢华和新鲜多元的都会生活。

HC28 COSMO is a unique brand reinterpreting sleek luxury in modern and sophisticated style. Collaborating with renowned designers like Christophe Delcourt, Yonoh, Steve Leung and Roderick Vos, the brand has developed a versatile, trendy, fresh and elegant furniture collection. By its art of craft, HC28 COSMO represents a new cosmopolitan lifestyle in high quality and versatility.

DESIGNER

设计师

08-15

---

LIVING ROOM

客厅

16-79

DINING ROOM

餐厅

80-95

BEDROOM

卧室

96-115

---

PRODUCT INDEX

产品目录

116-173

# In conversation with STEVE LEUNG 梁志天

当代中国设计的领军人物  
A leading character in contemporary design in China



**Q: 在为 HC28 都汇里 创作的过程中, 令您印象最深刻的事情是什么?**

A: 印象最深刻的是我和团队在创作过程中的思考。“都汇里”是一个体现都市精神的系列。都市大多给人一种喧嚣、复杂的印象, 所以我们希望通过这个作品展现出都市生活的另一面: 生机勃勃、充满机遇、格调不凡。我们透过极简现代的设计, 流畅及有节制感的曲线来塑造这些气质, 创造出一组现代优雅而又有温度的作品。

**Q: 您为 HC28 都汇里 设计的产品的主人是什么样的? 您希望通过您的作品传达给用户哪种生活方式和观念?**

A: “都汇里”的主人, 一定是一个注重生活品质的人, 懂得在繁忙的都市生活中, 静下来享受生活之美。同时, 也会是一个非常具有想法, 不轻易随波逐流的人, 对自己的品味十分自信。

我希望用户可以从我们的作品中感受到都市生活的另一面, 充满活力, 格调不凡, 那是一种积极进取, 勇于开拓的都市精神。

**Q: 您此次为 HC28 都汇里 设计的产品系列, 有什么特别的意义?**

A: 这个系列的名字很有趣, 叫做“UOVO”, 是意大利语中“蛋”的意思, 因为我们的设计灵感就是来自于像鸡蛋一样柔润流畅的线条和造型, 让人感觉放松舒适, 优雅之余也不失玩味。同时, 蛋也是生命孕育的开始, 寓意着活力和希望, 又充满惊喜, 就像都市中的年轻人。这个系列的现代极简设计和灵活组合, 正展现了这些气质和态度。

**Q: 在您眼中, HC28 都汇里 是一个什么样的品牌? 可以用一句话或几个词概括一下吗?**

A: “都汇里”就像一颗漫步在曼哈顿 SOHO 的年轻跳动的心。它有活力、有态度、有温度。



**Q: What was the most impressive thing during cooperation with HC28 COSMOPOLITAN?**

A: I'm delighted by how our team drives the creation and the thoughts of it. The brand is a collection that presents the spirit of metropolitan life. A metropolis is often bustling and complex. We hope to present the other side of metro life: one marked by vitality, opportunity, and unique tastes. We use controlled curves to create a simple but modern shape and look. The collection is fun, elegant, and with character.

**Q: What do you think the HC28 COSMOPOLITAN users look like? What lifestyles and ideas do you hope to convey to users through your design?**

A: The brand furniture owners lead a quality life. They take time to slow down and enjoy the beauty of life. They are leaders who set the trends with their distinctive tastes rather than following them.

In this new collection, we hope to bring users the dynamism and character of a metropolitan life. It is a place where people create, break through and appreciate sophistication.

**Q: Does your design for HC28 COSMOPOLITAN have any special meaning?**

A: Our new collection "UOVO" which means "egg" in Italian, is inspired by its smooth and controlled curves. It also symbolizes the beginning of a new life that's vibrant, hopeful and often surprising, similar to the young metropolitans. Our contemporary and minimal design with flexible compositions represents this attitude.

**Q: In your eyes, what kind of brand is HC28 COSMOPOLITAN? Can you summarize it briefly?**

A: The brand is a beating young heart in SOHO of Manhattan. It is energetic, charismatic and genuine.

# In conversation with CHRISTOPHE DELCOURT

天才设计师  
A gifted designer



**Q: 在为 HC28 都汇里 创作的过程中, 令您印象最深刻的事情是什么?**

A: 这次合作中最令人惊叹的是厉先生和其团队的工作热情和力量, 我们的交流非常顺畅, 每次工厂讨论样品的会议总是收获颇丰, 他们对于我的意见, 甚至苛求始终全力配合。

**Q: 您为 HC28 都汇里 设计的产品的主人是什么样的? 您希望通过您的作品传达给用户哪种生活方式和观念?**

A: “都汇里”面向的人群是那些热爱旅行、深谙文化与时尚之道的人, “都汇里”通过这些精致的作品和独有的细节, 服务于那些对品质要求极高的人群。

**Q: HC28 都汇里 在您眼中是一个什么样的品牌?**

A: “都汇里”是一个处于潮流前沿, 于细节中彰显鲜明个性的现代家具品牌。

**Q: What was the most impressive thing during cooperation with HC28 COSMOPOLITAN?**

A: Ce qui m'impressionne le plus est la force de travail de Mr LI et de ses équipes. Les échanges sont très fluides et les réunions autour des prototypes à l'usine sont toujours très productives. Il y a une véritable écoute par rapport à mes demandes et parfois mes exigences.

**Q: What do you think the HC28 COSMOPOLITAN users look like? What lifestyles and ideas do you hope to convey to users through your design?**

A: HC28 COSMOPOLITAN s'adresse à une clientèle qui voyage beaucoup et qui s'intéresse à la culture, à la mode...HC28 COSMOPOLITAN par ses détails et ses finitions sophistiqués se fait l'écho d'une clientèle exigeante.

**Q: In your eyes, what kind of brand is HC28 COSMOPOLITAN? Can you summarize it briefly?**

A: HC28 COSMOPOLITAN est une marque de mobilier contemporain aux lignes actuelles composées de détails qui lui confère une identité singulière.



# In conversation with SEBASTIAN HERKNER

传统工艺的“创新者”  
An innovator of traditional artisantry



传统工艺与现代设计之间的桥梁，是新生力量的代表。

1981 出生的德国设计师 Sebastian Herkner 作为德国奥芬巴赫设计学院 (Offenbach University of Art and Design) 的优秀毕业生，通过独特的造型、经典的材料以及拼接的色彩，为德国乃至世界带来了全新的设计，并柔化了“德国设计”在大众心中的形象，更在 2019 年被评选为 MAISON&OBJET PARIS 年度设计师。

2006 年他成立工作室以来，为众多知名家具品牌设计产品，如意大利家具品牌 Moroso、德国户外家具品牌 Dedon、德国百年家具品牌 Thonet，以及荷兰家居品牌 Lintello 等。

2020 年，Sebastian Herkner 携手都汇里品牌，设计了如 BERLIN 柏林沙发、GEM 合璧扶手椅、GRASSI 格萨茶几等一系列精彩作品，兼顾传统与现代的设计，对色彩的独到眼光，注重不同文化的融合，这些内涵都在这些作品中表达的淋漓尽致。

Sebastian Herkner (born 1981) studied Product Design at HfG Offenbach University of Art and Design. During his studies he began to focus on designing objects and furniture, honing his keen sense for materials, colors and textures. For a short while he then worked for Stella McCartney in London.

In the year 2006 Sebastian Herkner founded his own studio. Since that time, he has designed furniture, lamps and smaller items for manufacturers such as Ames, and Tradition, Cappellini, ClassiCon, Dedon, Ex.t, Fontana Arte, Gubi, Lintello, Moroso, Pulpo, Rosenthal, Schramm Werkstätten, Thonet, Wittmann and Zanotta. Herkner also realizes interior architecture projects and museum and exhibition design.

His works have won numerous accolades – among others the IF Award,

the Iconic Award and the Elle Deco International Design Award (EDIDA). As Guest of Honor to imm cologne 2016, Sebastian Herkner provided the design for “Das Haus”. Maison&Objet has elected him 2019 “Designer of the Year”.





## In conversation with STUDIO RODERICK VOS

趣玩设计 CP  
Curious and Playful Design Couple



Roderick 与 Claire Vos 1990 年毕业于埃因霍温设计学院。Roderick 本身就有亚洲血统，在日本工作期间对亚洲文化产生极大的兴趣，这段经历也对他的个人创作产生了很大的影响。Claire Vos 作为一名纺织品设计师，密切关注材质本身，热衷于重新诠释传统技术、色彩和形式。

1999 年，他们决定在荷兰赫斯登成立共同的设计室 Studio Roderick Vos，致力于创新的工作室主要从事灯饰、纺织品、配饰和家具设计，与 Driade、Moooi、Linteloo & Cor Unum 等众多国际品牌合作。

自 2016 年起，夫妇二人共同担任荷兰家具品牌 PODE 的艺术总监。他们设计的每件产品，都饱含他们对工艺技术、材料和颜色的精益求精。

Roderick and Claire Vos are both graduated in 1990 from the Academy of Industrial Design at Eindhoven's "Design Academy".

Being partly Asian himself, his working experience in Tokyo during 1987, as a trainee, evidently had a large impact on Roderick's personal interest in Asian Culture and his style in design. Production of textiles and ceramics has been in Claire Vos's family for generations. As a textile designer, Claire Vos specializes in re-interpreting traditional techniques, colorings and forms, paying close attention to the quality of the materials she uses.

In 1999 Claire & Roderick Vos officially started their design office 'Studio Roderick Vos', based in Heusden Vesting, the Netherlands. This innovative studio works mainly in lighting, textile, accessories and furniture design and has been cooperating with international brands such as Driade, Moooi, Linteloo & Cor Unum.

Since 2016 they both became art directors for Dutch furniture brand PODE. Each of their products is characterized by careful research and passion for technology, material and color.



# LIVING ROOM

---

客厅



Sofa 沙发 / BERLIN 柏林    Coffee table 茶几 / GRASSI 格萨    Armchair 单人位 / CINI 旖旎    Cabinet 书柜 / STRATA 斯巴达  
Side table 边几 / STAGE 云台、CONE 科恩、MOON 尚月





## BERLIN 柏林

Sebastian Herkner

BERLIN 沙发的灵感来自于柏林的精神：可变性，永恒性和现代性，而这也正是这款组合沙发带给我们的惊喜。其简洁的曲线和比例，轻松舒适的坐感，形神兼备的细节，体现主人热情好客的态度。多变的组合模块，也可轻松适应户型与空间的大小。

BERLIN sofa is inspired by the spirit of the city: ever-changing, eternal and modern. The simplicity of its curves and proportions, cozy feeling and details connecting appearance with inner beauty altogether underline the generosity and hospitality from the host. Its changeable modules allow the piece to fit different spaces.

## CINI 旖旎

Dainelli Studio

CINI 单人位，承袭法国 18 世纪藤编围手椅的完美比例，以金属框架重塑经典，坐垫与靠背弧度勾勒出旖旎姿态，厚度填充饱满紧实，围合出亲近与欢迎感，并具备感染空间的表现力。

CINI single chair inherits the flawless proportion of the 18th-century rattan armchair with its metal frame and gorgeous curves of fully stuffed cushion and back. Intimacy can be felt in its hug. A space will be highlighted by the chair.





## STRATA 斯巴达

Studio Roderick Vos

STRATA 是一个充满硬核工业风的柜体系列。从明代设计与极简主义中汲取灵感，用现代设计语言书写出的柜体史诗，简洁中饱含力量，平仄间层次分明。利用工业技术实现手工工匠制造外观，高品质烤漆工艺，让柜体表面呈现出流动的光泽感，无须过多的外在修饰，就已足够利落硬朗。

STRATA collection contains a series of hardcore industrial-style cabinets. Its inspiration comes from Ming-Dynasty design and minimalism. Simple with power and clearly structured, the collection writes an epic of cabinet in a design language of today. Modern technology is applied to form the exterior which was used to be made by hand. High-end baking varnish adds fluid light on the surfaces. The cabinets speak for themselves with no need of extra decoration.



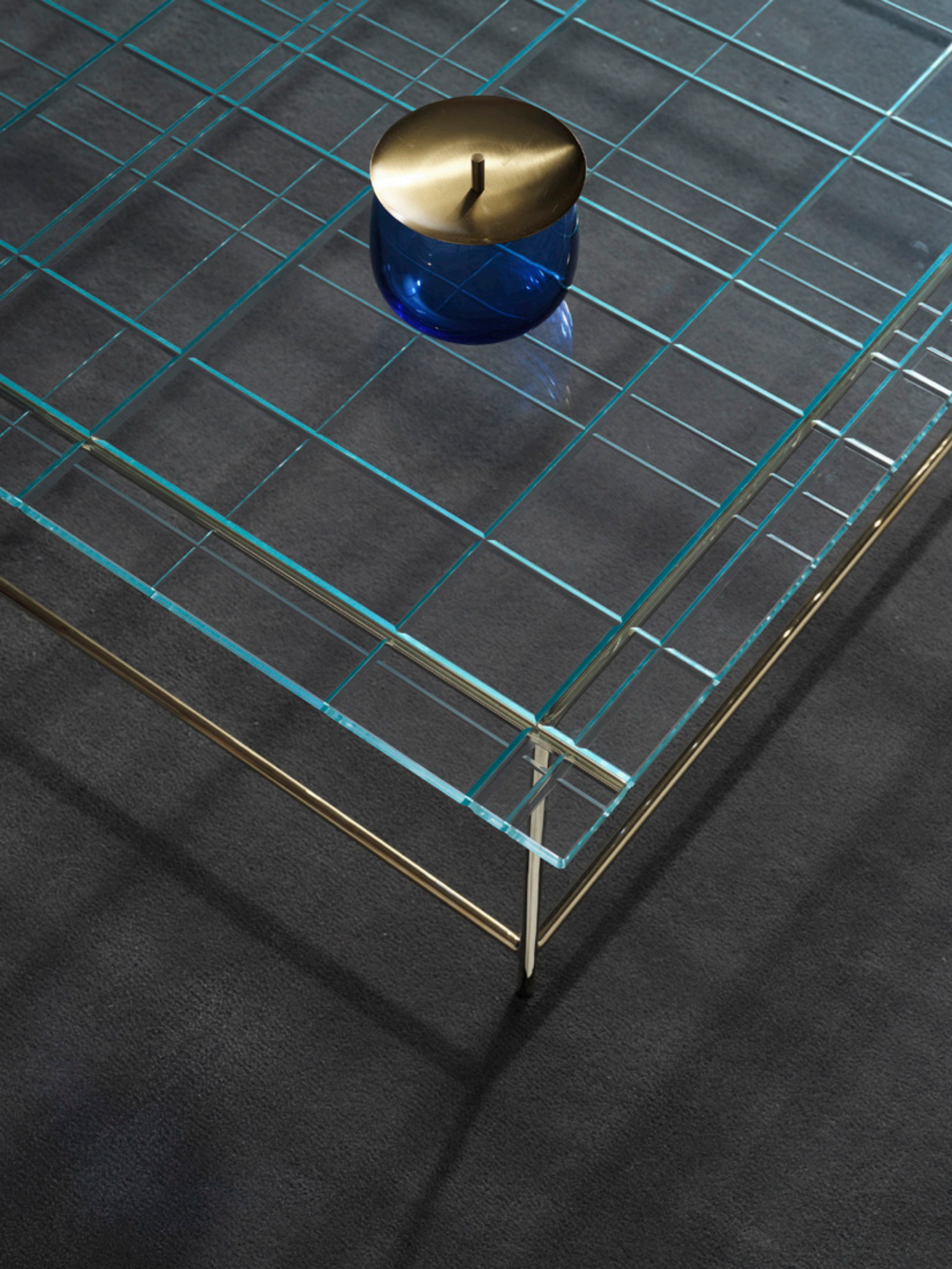

## GRASSI 格萨

Sebastian Herkner

GRASSI 系列灵感源自德国 GRASSI MUSEUM 的馆藏艺术品令人惊叹的工艺，同时也受到欧洲教堂玻璃窗的启发，精致的金属结构与厚实透明的玻璃桌面形成鲜明对比，几何切割条纹在光线下呈现出迷醉的光影，使客厅空间虚实有致。

GRASSI collection is inspired by the amazing quality of craftsmanship in the Grassi Museum in Germany and the glass windows in European cathedrals. The delicate metal structure is in solid contrast with the transparent glass tabletops. The geometric cuttings of lines are reflecting light in a fascinating way. With the presence of the item, a living room becomes a mixture of reality and illusion.





Sofa 沙发 / FIL 风尚 Coffee table 茶几 / CRI 可瑞 Armchair 单人位 / GIO 山谷  
Side table 边几 / ZEN 冰心 Living cabine 电视柜 / TRHYTHM 半岛



Sofa 沙发 / UOVO 源    Coffee table 茶几 / UOVO 源  
Armchair 单人位 / UOVO 源    Side table 边几 / Zen 冰心、UOVO 源







## FIL 风尚

### Yonoh

FIL 沙发系统，用平滑流畅的弧度勾画出饱满明朗的气度，用宽大的坐席让惬意蔓延。其标志型的靠背，可以高低结合，塑造出层次生动的轮廓，并以独特的宽榻围合出唯美优雅的空间。

Smooth and clean lines create a plump and bright style for FIL sofa. The wide seats are cozy. Its unique chaise builds an artistic space of elegance, and its signature back is composed of cushions with different heights, creating a vivid outline.

## CRI 可瑞

Archirivolto Design

简洁精致的不锈钢底架，托起圆形桌面，并形成一个不锈钢围边，既和桌面嵌套又离开桌面互相呼应，这些精巧而新鲜的细节，让茶几气质脱俗，雅致好用。桌面可选木质或大理石。

A bright and sophisticated stainless steel frame supports the round top. The edge both covers the tabletop and sets it apart. These exquisite and creative details give this coffee table extraordinary charm. Not only it is elegant, but it is also thoughtful and useful. The top material can be either wood or marble.





## GIO 山谷

Christophe Delcourt

GIO 单人沙发，用斜线和角度的语言展现出有力度的优雅，并通过精确的设计和做工，塑造了视觉的趣味和美感，看似轻松的几何态结构呈现了相当宜人的舒适感。

GIO armchair, a graceful furnishing, is built of diagonal lines and angles. The precise and neat design and spectacular craftwork make it a joy to behold. The geometric structure makes it fit comfortably in any contemporary room.

Sofa 沙发 / SHELL 沃野 Coffee table 茶几 / GRANTORINO 都灵 Armchair 单人位 / DEBBIE 多彼  
Side table 边几 / OVO 星空、GRANTORINO 都灵 Living cabinet 电视柜 / TRHYTHM 半岛









## SHELL 沃野

Frank Chou 周宸宸

SHELL 沙发拥有利落的线条，底座平坦广袤，包裹的柔软坐垫似沃野，厚实坦荡舒适，颇具雕塑感的金属腿部抬高坐面，为空间留下通透的呼吸感。双层靠包的搭配提供了更加灵活与多样化的使用姿态，营造出松弛而优雅的当代品质生活。

SHELL sofa has a clear outline and a wide base. The soft cushions are thick and comfortable. The sculpture-like metal legs lift the seats to make a room for breath. The double-layered backs are more flexible for users to enjoy a relaxing and tasteful time.







Sofa 沙发 / Michel 米其    Coffee table 茶几 / Plan 普兰  
Armchair 单人位 / Gio 山谷    Bookcase 书柜 / Rhythm 半岛



## MICHEL 米其

Yonoh

大气而精致的 MICHEL 沙发，用双层包制的底架呈现复合的层次，用成双的束腿表现趣味，用宽大的坐席和由厚而薄的扶手表达舒适。如果你在寻找一个既气派又亲切，既得体又有趣，既百搭又新鲜的沙发，MICHEL 定然不会让你失望。

MICHEL sofa has an exquisite elegant appearance. Its sophisticated structure is presented in a double layer covered frame with paired legs. The sofa has a wide, comfortable seat and an arm that graduates from thick to thin. If you are looking for an interesting sofa that combines splendid and coziness, and which matches anything while remaining unique, MICHEL sofa will not disappoint.



Sofa 沙发 / GEM 合璧 Coffee table 茶几 / CRI 可瑞 Armchair 单人位 / DEBBIE 多彼  
Side table 边几 / CONE 科恩 Living cabine 电视柜 / STRATA 斯巴达



## GEM 合璧

Sebastian Herkner

GEM 系列是东西合璧的佳作，从 GEM 系列可窥见 20 世纪 60 年代现代派风格缩影，似缎带的镀铜拉丝扶手颠覆传统沙发扶手设计，浑圆厚实像一颗宝石般的软包坐垫被“金属缎带”环绕，像一份精致的礼物，躺在客厅中等待被探索与开启。

GEM collection is a masterpiece combining the designer's European background and the experience in China. Modernism design of the 1960s can be detected in the items. The gem-like padded upholstery is surrounded and accented by the ribbon-shaped arms made of brass. The whole piece looks like a delicate present waiting to be opened up in a living room.





Sofa 沙发 / BARRY 百瑞 Coffee table 茶几 / CRI 可瑞 Armchair 单人位 / CALA 朵朵  
Side table 边几 / CONE 科恩、ZEN 冰心 Bookcase 书架 / UO 优沃



## BARRY 百瑞

Ximi Li 李希米

BARRY 沙发，内外高低的层叠双扶手设计，整体造型圆润柔和，给人双层的包裹感，既活跃又不浮夸，颇有“内衣外穿”的时尚表达。金属腿与金属条包边一气呵成，给人以年轻且时尚的视觉体验。

BARRY sofa's arms are composed of two layers of cushions of different heights. Wrapped in leather, contains two high and low tiers. The appearance looks soft, vivid and chic. The metal legs and edge are connected smoothly to create a young and stylish look.







## ENEA 恩亚

Archirivolto Design

ENEA 边几外形简约优雅，桌面饰以不同材质，柔软皮革表面与坚实木饰面形成对比，从视觉上给予时尚的感受，错层桌面设计构建出别致的空间关系，层次分明却浑然一体。小巧的外观让 ENEA 边几适用于各种空间。

ENEA side table is characterized with a simple outline and minimal lines. It's embellished with various materials. The soft leather is in contrast with the hard walnut surface. Crossed tabletops build a unique space, separated yet integrated. Its size makes the table suitable for any room.

## NEST 巢

Studio Roderick Vos

NEST 沙发拥有绽放式的趣味造型，散发着温馨与欢乐。立领般的围合环绕着扶手和靠背，与坐席相连，并以弹性面料包覆出柔软的雕塑感。整体唯美贯通的缝线，让沙发神采奕奕，为休闲浪漫的空间营造着放松的氛围。

NEST sofa resembles blooming blossoms and contains coziness and cheerfulness. Its unique enclosure embraces the armrests and back and connects the seats. Covered with elastic fabrics, the sofa looks like a soft sculpture. Artistic piping line runs through its whole body and brings vitality. It builds a relaxing and romantic space.



Sofa 沙发 / Round 日月 Coffee table 茶几 / Cri 可瑞  
Armchair 单人位 / Gio 山谷 Side table 边几 / Zen 冰心 / Ovo 星空





Sofa 沙发 / UOVO 源    Coffee table 茶几 / UOVO 源  
Armchair 单人位 / UOVO 源    Side table 边几 / Zen 冰心、UOVO 源

## UOVO 源

Steve Leung 梁志天

UOVO 系列的设计从美学到功能，从概念到工艺都展示着简约奢华的现代感。其纯熟自如的流线勾勒出高级的都会气息，转折，围合，绽放，收尾，都在充满节制感的曲线中呈现出最美的优雅。

UOVO collection is a combination of aesthetics and functionality. The contemporary and minimal design is characterized by its fluid and smooth lines created by the excellent craftsmanship, and it gives a sense of relaxation, elegance and personality to the collection.





# DINING ROOM

---

餐厅





## GAUDI 高迪

Archirivolto Design

高迪餐桌，从新哥特式风格建筑元素中汲取灵感，像一件结构感十足的雕塑作品。拱形金属底座，受到自然蜿蜒的曲线启示，优雅有序的簇拥在一起，承托着桌面，在曲面折射的光影变化中，散发着迷人的生命力。

The sculpture-like GAUDI dining table draws inspiration from neo-gothic architecture. The idea of arching metal base comes from curves in nature. They stand together gracefully to prop up the table. Light is refracted vigorously on the curved surfaces.



Dining table 餐桌 / Siff 江月  
Sideboard 边柜 / Gru 律动  
Chair 椅子 / Bola 飞燕





## SIFF 江月

Christophe Delcourt

SIFF 餐桌通透、灵动，充满未来的现代感，桌腿结构以“半圆展翅”的形态，托举着延伸感的玻璃桌面，木质的柱体与灰色玻璃的轻透，更是虚实有致，充满了构成般的画面感。

SIFF is a transparent dining table that is futuristic and contemporary. Its legs are semi-round and stretch like wings lifting the glass top. The dark wood pillar lifts up the light gray glass for a light and sturdy structure that is well composed.



Dining table 餐桌 / Miami 迈阿密 Sideboard 边柜 / Lonja 龙佳 Chair 椅子 / Encontra 轻舟





# BEDROOM

---

卧室

Bed 床 / BARRY 百瑞    Sofa 沙发 / BARRY 百瑞  
Side table 边几 / TILE 泰然、PLUS 佳怡    Bookcase 书架 / UO 优沃





## BARRY 百瑞

Ximi Li 李希米

BARRY 床，透出精致的绅士气息，皮质包角，营造高低的内外层叠效果，整体造型圆润柔和，给人双层的包裹感，既活跃又不浮夸，颇有“内衣外穿”的时尚表达。金属腿与金属条包边一气呵成，给人以年轻且时尚的视觉体验。

BARRY collection composed of two layers of cushions of different heights. Wrapped in leather, the head of BARRY bed also contains two high and low tiers. The appearance looks soft, vivid and chic. The metal legs and edge are connected smoothly to create a young and stylish look.

## TILE 泰然

Yonoh

TILE 边几是一款含储物功能的圆边几，桌面以浓厚温润的倒角收边，和底部精致的金属托盘形成对比。而边几的底脚以金色不锈钢作为收头，透露着清新时尚的气息。

TILE is a round side table that functions as a storage unit. Its top has thick and smooth chamfering, which contrasts with the finely made metal tray on the bottom. The feet of the table with golden tips, which look fresh and fashionable.





## UO 优沃

### Hi Thanks Bye

不规则的搁架设计，带给人不一样的视觉冲击力，个性十足。“窗口”和“夹心”的位置都有放置物品的不同方式，UO 透过每个窗口与外界进行对话，也将内部的收纳调理出趣味。外向，内向，都是向美而生。

The irregular shelves create a special visual effect. People can store stuffs on the 'window' and 'hollow' in different ways. UO bookcase speaks to the world through each window with fun. Various types of beauty can be felt.

Bed 床 / UOVO 源 Armchair 单人位 / UOVO 源 Desk 书桌 / Largo 罗曼 Bedside Table 床头柜 / Anni 悠然





## UOVO 源

Steve Leung 梁志天

UOVO 床，用流畅的曲线勾勒出最舒适的弧度，转折，围合，绽放和收尾都在可控的曲线中，展现低调奢华的气质，并给卧室一份雅致的格调。

UOVO bed uses gentle and smooth curves to evoke the feeling of sanctuary. The subtle and comfortable form embody artistry and it sets the tone of a bedroom with understated luxury.

Bed 床 / Lonja 龙佳    Armchair 单人位 / Lovy 洛维    Sideboard 边柜 / Lonja 龙佳  
Side table 边几 / Tile 泰然、Zen 冰心







## LONJA 龙佳

Santiago Sevillano

LONJA 床由枕头造型演绎出的舒适感，让卧室的气氛轻松惬意，香槟金色的床腿灵感源于西班牙 LONJA 教堂中庭的立柱造型，它们纤细精巧，笔直地向上伸展，承托着舒适的床身，使整体协调有致，彰显生活中的设计之美。

LONJA bed is inspired by a pillow shape, and its comfy feeling will make your bedroom cozy and chic. Its champagne colored legs are inspired by the LONJA church pillar in Spain. They are thin and sophisticated, stretching up straight and supporting the comfortable bed. The whole piece shows well proportioned and charming design.



# PRODUCT INDEX

## 产品目录

沙发 SOFA	118-137
单人位 ARMCHAIR	138-141
茶几 COFFEE TABLE	142-145
边几 SIDE TABLE	146-149
条案 CONSOLE	150
电视柜 LIVING CABINET	151-153
餐桌 DINING TABLE	152-156
椅子 CHAIR	157-160
餐边柜 SIDEBOARD	161-163
床 & 床头柜 BED & BEDSIDE TABLE	164-169
书桌 & 书架 DESK & BOOK CASE	170-171
配饰 ACCESSORY	172
地毯 RUG	173

# SOFA

## 沙发



**NEST 巢**  
Studio Roderick Vos



尺寸: 1160\*912\*720mm  
1960\*912\*720mm  
2360\*912\*720mm  
编号: 31F014

**框架结构:** 框架为实木与多层板结构, 金属沙发底脚 / **饰面:** 主体为软包面料, 黑色烤漆金属底脚 / **坐垫软包:** 坐垫为高弹海绵复合, 最上层为蓬松棉填充 / **面料:** 沙发套不可拆卸, 指定弹性面料, 颜色可选 / **靠包:** 没有靠包

**STRUCTURE:** Structure in solid wood and plywood, feet in metal / **FINISHING:** Upholstered with fabric, feet in black lacquered metal / **SEAT CUSHION:** Seat cushion in high density foam polyurethane and dacron / **COVERING:** Non-removable covering in elastic fabric / **CUSHIONS:** No cushions

**GEM 合璧**  
Sebastian Herkner



尺寸: 760\*800\*700mm  
1970\*800\*700mm  
编号: 31F018

**框架结构:** 框架为实木与多层板结构, 金属扶手 / **饰面:** 沙发整体为软包面料, 扶手为不锈钢拉丝 / **坐垫软包:** 坐垫为高弹海绵复合, 最上层为珍珠棉和羽绒混合填充 / **面料:** 沙发套不可拆卸, 多种面料可选 / **靠包:** 珍珠棉和羽绒混合填充, 纯棉靠包内套, 外套为可拆卸的面料

**STRUCTURE:** Structure in solid wood and plywood, armrest in metal / **FINISHING:** Upholstered with fabric, armrest with brushed brass stainless steel / **SEAT CUSHION:** Seat cushion in high density foam polyurethane and dacron / **COVERING:** Non-removable covering in fabric / **CUSHIONS:** Polyester padding and goose down with cotton pre-covering, removable covering in fabric

**BARRY 百瑞**  
Ximi Li 李希米

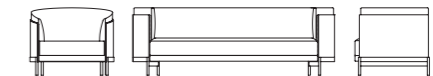

尺寸: 920\*850\*740mm  
2300\*850\*770mm  
编号: 31F019

**框架结构:** 框架为实木与多层板结构, 金属底脚 / **饰面:** 主体软包, 扶手外侧牛皮包制, 其他部位面料或牛皮包制, 其他部位牛皮包制时必须与扶手外侧牛皮颜色一致, 底脚为黑灰色氟碳漆 / **坐垫软包:** 坐垫为高弹海绵复合, 最上层为珍珠棉和羽绒混合填充 / **面料:** 沙发套不可拆卸, 多种面料或牛皮可选 / **靠包:** 珍珠棉和羽绒混合填充, 纯棉靠包内套, 外套为可拆卸的面料或牛皮套

**STRUCTURE:** Structure in solid wood and plywood, legs in metal / **FINISHING:** Outside of the armrest upholstered only in leather, other part covering in fabric or same leather as the outside of the armrest, legs in dark grey epoxy paint / **SEAT CUSHION:** Seat cushion in high density foam polyurethane, dacron and feather / **COVERING:** Non-removable covering in fabric or leather / **CUSHIONS:** Polyester padding and goose down with cotton pre-covering, removable covering in fabric or leather

**ROUND 日月**  
Yonoh

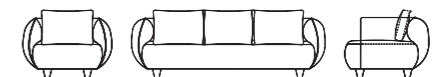

尺寸: 1020\*950\*680mm  
1920\*950\*680mm  
2220\*950\*680mm  
编号: 31F005

**框架结构:** 框架为实木与多层板结构 / **饰面:** 沙发整体为软包面料或牛皮, 地脚为白色或黑色丝光烤漆 / **坐垫软包:** 坐垫为高弹海绵复合, 最上层为蓬松棉填充 / **面料:** 沙发套不可拆卸, 多种面料或牛皮可选 / **靠包:** 珍珠棉和羽绒混合填充, 纯棉靠包内套, 外套为可拆卸的面料或牛皮套

**STRUCTURE:** Structure in solid wood and plywood / **FINISHING:** Upholstered with fabric or leather, legs in silk white or black lacquer / **SEAT CUSHION:** Seat cushion in high density foam polyurethane and dacron / **COVERING:** Non-removable covering in fabric or leather / **CUSHIONS:** Polyester padding and goose down with cotton pre-covering, removable covering in fabric or leather

**BOL 元阳**  
Christophe Delcourt



尺寸: 1020\*835\*632mm  
2000\*835\*632mm  
2250\*835\*632mm  
编号: 31F004

**框架结构:** 框架为实木与多层板结构 / **饰面:** 主体为软包面料, 底座为胡桃木或染色橡木 / **坐垫软包:** 坐垫为高弹海绵复合, 最上层为蓬松棉填充 / **面料:** 沙发套不可拆卸, 多种面料可选 / **靠包:** 珍珠棉和鹅绒混合填充, 纯棉靠包内套, 外套为可拆卸的面料

**STRUCTURE:** Structure in solid wood and plywood / **FINISHING:** Upholstered with fabric, base in natural walnut or stained oak / **SEAT CUSHION:** Seat cushion in high density foam polyurethane and dacron / **COVERING:** Non-removable covering in fabric / **CUSHIONS:** Polyester padding and goose down with cotton pre-covering, removable covering in fabric

**HAP 哈伯**  
Christophe Delcourt

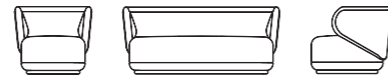

尺寸: 780\*790\*680mm  
1600\*810\*680mm  
2000\*810\*680mm  
编号: 31F013

**框架结构:** 框架为实木与多层板结构, 木质底座 / **饰面:** 沙发主体为软包面料或皮, 内侧和外侧的选择可不同, 金色烤漆底座 / **坐垫软包:** 坐垫为高弹海绵复合, 最上层为蓬松棉填充 / **面料:** 沙发套不可拆卸, 多种面料或牛皮可选 / **靠包:** 没有靠包

**STRUCTURE:** Structure in solid wood and plywood, base in wood / **FINISHING:** Upholstered with fabric and/or leather, and the options can be different for inside and outside of the back and arms, base in gold lacquer / **SEAT CUSHION:** Seat cushion in high density foam polyurethane and dacron / **COVERING:** Non-removable covering in fabric or leather / **CUSHIONS:** No cushions

**LONJA 龙佳**  
Santiago Sevillano



尺寸: 1800\*880\*770mm  
2200\*880\*770mm  
编号: 31F003

**框架结构:** 框架为实木与多层板结构, 金属底座 / **饰面:** 沙发主体为软包面料, 底座为黑色丝光烤漆金属或者香槟金镀钛不锈钢 / **坐垫软包:** 坐垫为高弹海绵复合, 最上层为蓬松棉和羽绒填充 / **面料:** 沙发套不可拆卸, 多种面料可选 / **靠包:** 珍珠棉和鹅绒混合填充, 纯棉靠包内套, 外套为可拆卸的面料套

**STRUCTURE:** Structure in solid wood and plywood, base in metal / **FINISHING:** Upholstered with fabric, base in silk black lacquered metal or champagne titanium plating stainless steel / **SEAT CUSHION:** Seat cushion in high density foam polyurethane, dacron and feather / **COVERING:** Non-removable covering in fabric / **CUSHIONS:** Polyester padding and goose down with cotton pre-covering, removable covering in fabric

**LONJA 龙佳**  
Santiago Sevillano



单扶 LEFT/RIGHT ONE-ARMED SOFA

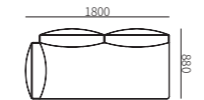

尺寸: 1800\*880\*770mm  
编码: 31F003-21

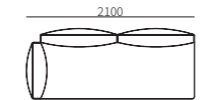

尺寸: 2100\*880\*770mm  
编码: 31F003-22

单背 SIDE TABLE

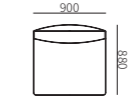

尺寸: 900\*880\*770mm  
编码: 31F003-31

边几 SIDE TABLE

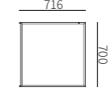

尺寸: 716\*700\*380mm  
编码: 31F003-51

转角 LEFT/RIGHT CHAISE

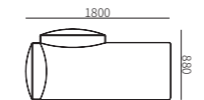

尺寸: 1800\*880\*770mm  
编码: 31F003-41

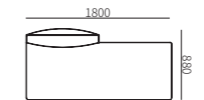

尺寸: 1800\*880\*770mm  
编码: 31F003-42

角位 LEFT/RIGHT CORNER SEAT

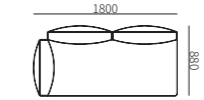

尺寸: 1800\*880\*770mm  
编码: 31F003-61

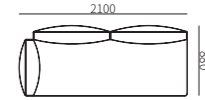

尺寸: 2100\*880\*770mm  
编码: 31F003-62

组合沙发 SECTIONAL SOFA

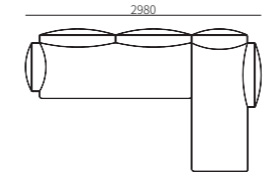

尺寸: 2980\*1800\*770mm  
编码: 31F003ZH-01

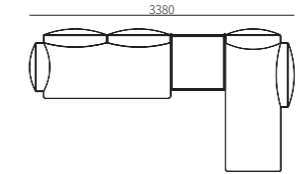

尺寸: 3380\*1800\*770mm  
编码: 31F003ZH-02

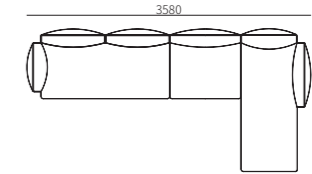

尺寸: 3580\*1800\*770mm  
编码: 31F003ZH-03

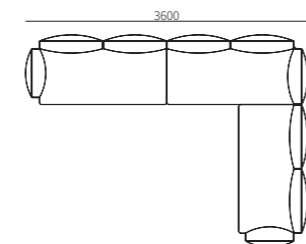

尺寸: 3600\*2680\*770mm  
编码: 31F003ZH-04

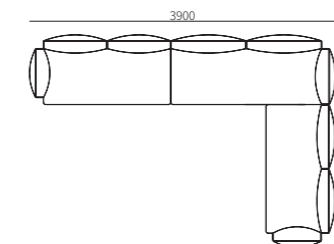

尺寸: 3900\*2680\*770mm  
编码: 31F003ZH-05

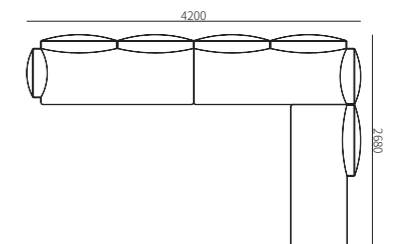

尺寸: 4200\*2680\*770mm  
编码: 31F003ZH-06

# BERLIN 柏林

Sebastian Herkner



编号: 31F016

**框架结构:** 框架为实木与多层板结构, 金属底脚 / **饰面:** 沙发整体为软包面料或牛皮, 黑丝光金属地脚 / **坐垫软包:** 坐垫为高弹海绵复合, 最上层为珍珠棉和羽绒混合填充 / **面料:** 沙发套可拆卸, 多种面料或牛皮可选 / **靠包:** 珍珠棉和羽绒混合填充, 纯棉靠包内套, 外套为可拆卸的面料或牛皮套

**STRUCTURE:** Structure in solid wood and plywood, legs in metal / **FINISHING:** Upholstered with fabric or leather, legs in silk black lacquered metal / **SEAT CUSHION:** Seat cushion in high density foam polyurethane, dacron and feather / **COVERING:** Removable covering in fabric or leather / **CUSHIONS:** Polyester padding and goose down with cotton pre-covering, removable covering in fabric or leather

## 沙发 SOFA

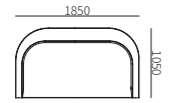

尺寸: 1850\*1050\*680mm  
编码: 31F016-12

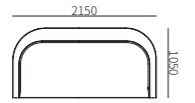

尺寸: 2150\*1050\*680mm  
编码: 31F016-13

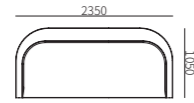

尺寸: 2350\*1050\*680mm  
编码: 31F016-14

## 单扶 LEFT/RIGHT ONE-ARMED SOFA

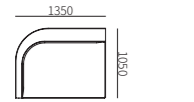

尺寸: 1350\*1050\*680mm  
编码: 31F016-21

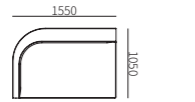

尺寸: 1550\*1050\*680mm  
编码: 31F016-22

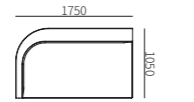

尺寸: 1750\*1050\*680mm  
编码: 31F016-23

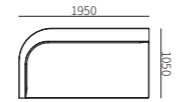

尺寸: 1950\*1050\*680mm  
编码: 31F016-24

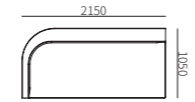

尺寸: 2150\*1050\*680mm  
编码: 31F016-25

## 单背 SOFA WITHOUT ARM

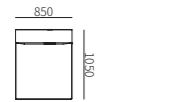

尺寸: 850\*1050\*680mm  
编码: 31F016-31

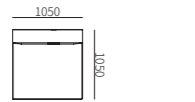

尺寸: 1050\*1050\*680mm  
编码: 31F016-32

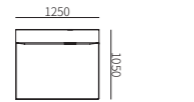

尺寸: 1250\*1050\*680mm  
编码: 31F016-33

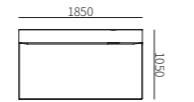

尺寸: 1850\*1050\*680mm  
编码: 31F016-34



尺寸: 1650\*1050\*680mm  
编码: 31F016-71

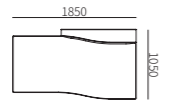

尺寸: 1850\*1050\*680mm  
编码: 31F016-72

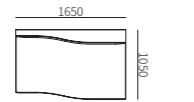

尺寸: 1650\*1050\*680mm  
编码: 31F016-73

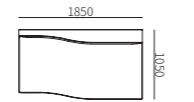

尺寸: 1850\*1050\*680mm  
编码: 31F016-74

## 转角 LEFT/RIGHT CHAISE

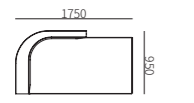

尺寸: 1750\*950\*680mm  
编码: 31F016-41

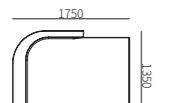

尺寸: 1750\*1350\*680mm  
编码: 31F016-42

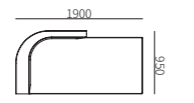

尺寸: 1900\*950\*680mm  
编码: 31F016-43

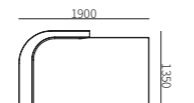

尺寸: 1900\*1350\*680mm  
编码: 31F016-44



## 榻 OTTOMAN

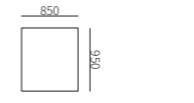

尺寸: 850\*950\*400mm  
编码: 31F016-51

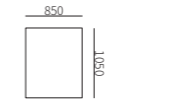

尺寸: 850\*1050\*400mm  
编码: 31F016-52

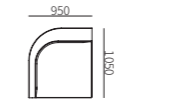

尺寸: 950\*1050\*680mm  
编码: 31F016-61

## 角位 LEFT/RIGHT CORNER SEAT

## 组合沙发 SECTIONAL SOFA

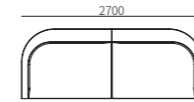

尺寸: 2700\*1050\*680mm  
编码: 31F016ZH-01

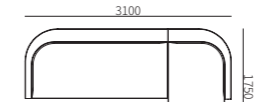

尺寸: 3100\*1750\*680mm  
编码: 31F016ZH-02

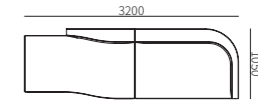

尺寸: 3200\*1050\*680mm  
编码: 31F016ZH-03

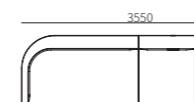

尺寸: 3550\*1900\*680mm  
编码: 31F016ZH-04

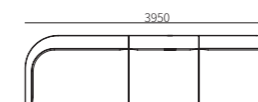

尺寸: 3950\*1900\*680mm  
编码: 31F016ZH-05

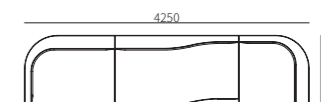

尺寸: 4250\*2800\*680mm  
编码: 31F016ZH-06

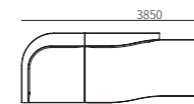

尺寸: 3850\*3100\*680mm  
编码: 31F016ZH-07

# SHELL 沃野

Frank Chou 周宸宸



编号: 31F017

框架结构: 框架为实木与多层板结构, 金属底脚 / 饰面: 靠背和座框为牛皮, 扶手、坐垫及靠垫为面料或皮, 底脚为黑灰色氟碳漆 / 坐垫软包: 坐垫为高弹海绵复合, 最上层为珍珠棉和羽绒混合填充 / 面料: 底框沙发套不可拆卸, 坐垫, 扶手, 靠包沙发套可拆卸, 多种面料或牛皮可选 / 靠包: 珍珠棉和羽绒混合填充, 纯棉靠包内套, 外套为可拆卸的面料或牛皮套

STRUCTURE: Structure in solid wood and plywood, legs in metal / FINISHING: Back and seat base upholstered only in leather, armrest, seat cushion and back cushion covering in fabric or leather, feet in dark grey epoxy paint / SEAT CUSHION: Seat cushion in high density foam polyurethane, dacron and feather / COVERING: Non-removable covering in fabric or leather / CUSHIONS: Polyester padding and goose down with cotton pre-covering, removable covering in fabric or leather

## 沙发 SOFA

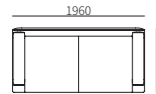

尺寸: 1960\*960\*690mm  
编码: 31F017-12

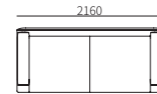

尺寸: 2160\*960\*690mm  
编码: 31F017-13

## 单扶 LEFT/RIGHT ONE-ARMED SOFA

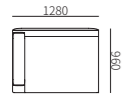

尺寸: 1280\*960\*690mm  
编码: 31F017-21

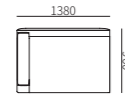

尺寸: 1380\*960\*690mm  
编码: 31F017-22

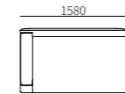

尺寸: 1580\*960\*690mm  
编码: 31F017-23

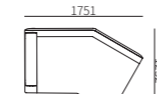

尺寸: 1751\*1252\*690mm  
编码: 31F017-24

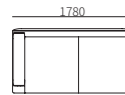

尺寸: 1780\*960\*690mm  
编码: 31F017-25

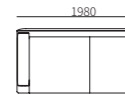

尺寸: 1980\*960\*690mm  
编码: 31F017-26

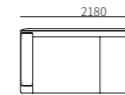

尺寸: 2180\*960\*690mm  
编码: 31F017-27

## 单背 SOFA WITHOUT ARM

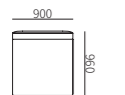

尺寸: 900\*960\*690mm  
编码: 31F017-31

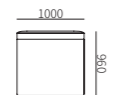

尺寸: 1000\*960\*690mm  
编码: 31F017-32

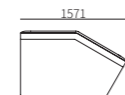

尺寸: 1571\*1252\*690mm  
编码: 31F017-33

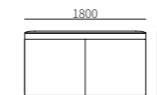

尺寸: 1800\*960\*690mm  
编码: 31F017-34

## 转角 LEFT/RIGHT CHAISE

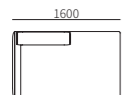

尺寸: 1600\*990\*690mm  
编码: 31F017-41

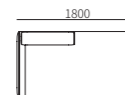

尺寸: 1800\*990\*690mm  
编码: 31F017-42

## 榻 OTTOMAN

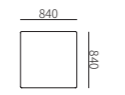

尺寸: 840\*840\*380mm  
编码: 31F017-51

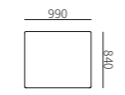

尺寸: 990\*840\*380mm  
编码: 31F017-52



## 角位 LEFT/RIGHT CORNER SEAT



尺寸: 960\*960\*690mm  
编码: 31F017-61

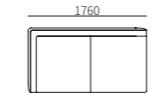

尺寸: 1760\*960\*690mm  
编码: 31F017-62

## 组合沙发 SECTIONAL SOFA

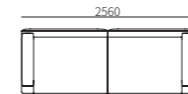

尺寸: 2560\*960\*690mm  
编码: 31F017ZH-01

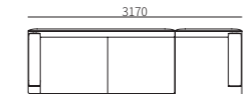

尺寸: 3170\*1600\*690mm  
编码: 31F017ZH-02

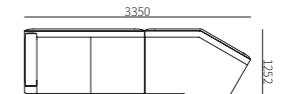

尺寸: 3350\*1252\*690mm  
编码: 31F017ZH-03

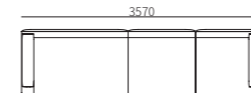

尺寸: 3570\*1800\*690mm  
编码: 31F017ZH-04

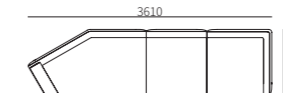

尺寸: 3610\*2740\*690mm  
编码: 31F017ZH-05

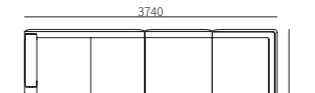

尺寸: 3740\*2600\*690mm  
编码: 31F017ZH-06

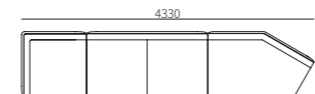

尺寸: 4330\*2940\*690mm  
编码: 31F017ZH-7



编号: 31F006

框架结构: 框架为实木与多层板结构, 金属底脚 / 饰面: 沙发整体为软包面料或皮, 底脚为黑色丝光烤漆金属 / 坐垫软包: 坐垫为高弹海绵复合, 最上层为蓬松棉填充 / 面料: 沙发套不可拆卸, 多种面料或牛皮可选 / 靠包: 珍珠棉和鹅绒混合填充, 纯棉靠包内套, 外套为可拆卸的面料或牛皮套

STRUCTURE: Structure in solid wood and plywood, base in metal / FINISHING: Upholstered with fabric or leather, feet in silk black lacquered metal / SEAT CUSHION: Seat cushion in high density foam polyurethane and dacron / COVERING: Non-removable covering in fabric or leather / CUSHIONS: Polyester padding and goose down with cotton pre-covering, removable covering in fabric or leather

沙发 SOFA



尺寸: 1000\*1000\*755mm  
编码: 31F006-11

尺寸: 2200\*1000\*755mm  
编码: 31F006-12

尺寸: 2600\*1000\*755mm  
编码: 31F006-13

尺寸: 2800\*1000\*755mm  
编码: 31F006-14

单扶 LEFT/RIGHT ONE-ARMED SOFA

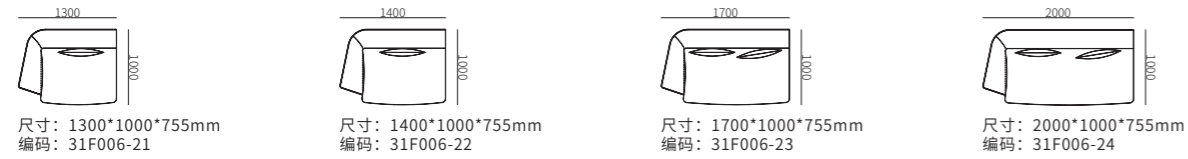

尺寸: 1300\*1000\*755mm  
编码: 31F006-21

尺寸: 1400\*1000\*755mm  
编码: 31F006-22

尺寸: 1700\*1000\*755mm  
编码: 31F006-23

尺寸: 2000\*1000\*755mm  
编码: 31F006-24

单背 SOFA WITHOUT ARM



尺寸: 1000\*1000\*755mm  
编码: 31F006-31

尺寸: 1200\*1000\*755mm  
编码: 31F006-32

尺寸: 1400\*1000\*755mm  
编码: 31F006-33

尺寸: 1700\*1414\*755mm  
编码: 31F006-34

转角 LEFT/RIGHT CHAISE

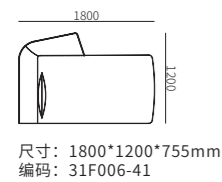

尺寸: 1800\*1200\*755mm  
编码: 31F006-41

角位 LEFT/RIGHT CORNER SEAT

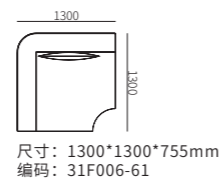

尺寸: 1300\*1300\*755mm  
编码: 31F006-61



组合沙发 SECTIONAL SOFA

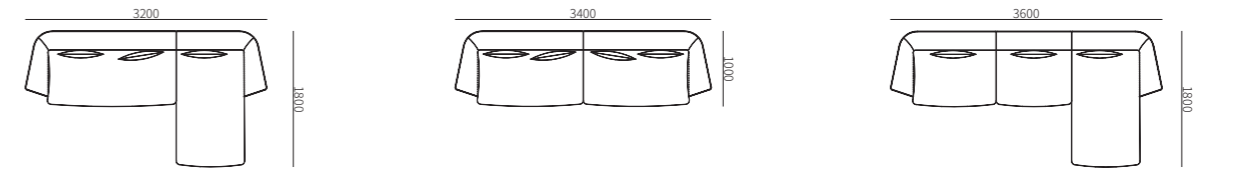

尺寸: 3200\*1800\*755mm  
编码: 31F006ZH-01

尺寸: 3400\*1000\*755mm  
编码: 31F006ZH-02

尺寸: 3600\*1800\*755mm  
编码: 31F006ZH-03

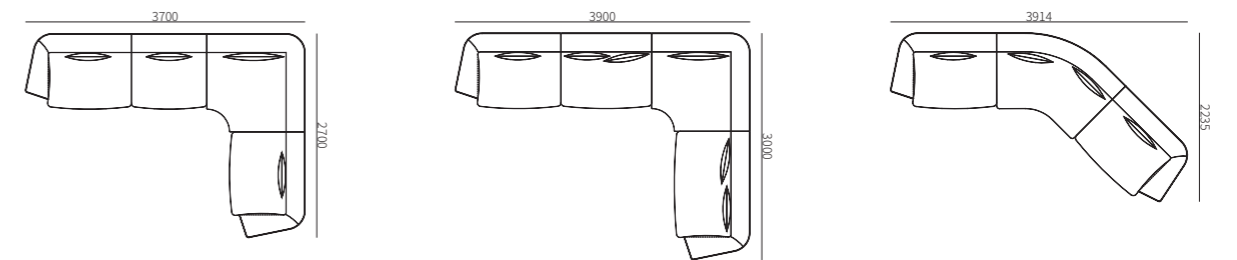

尺寸: 3700\*2700\*755mm  
编码: 31F006ZH-04

尺寸: 3900\*3000\*755mm  
编码: 31F006ZH-05

尺寸: 3914\*2235\*755mm  
编码: 31F006ZH-06

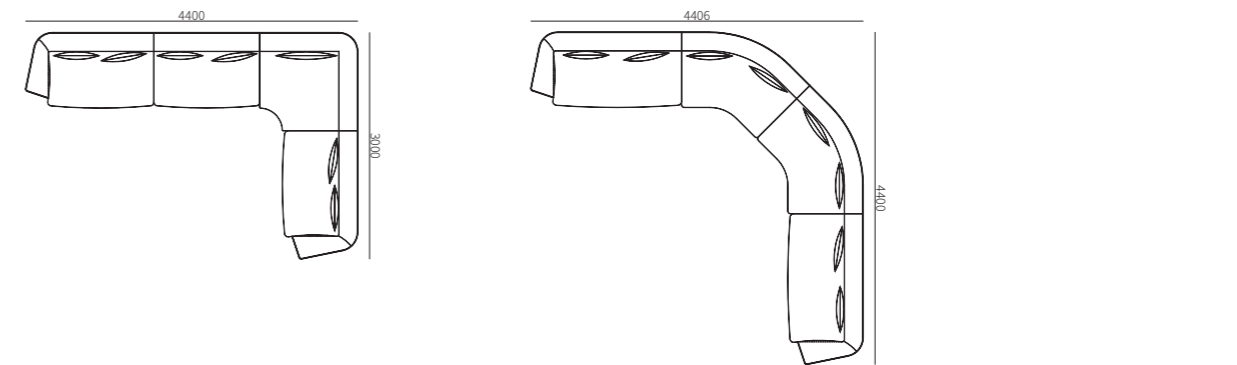

尺寸: 4400\*3000\*755mm  
编码: 31F006ZH-07

尺寸: 4406\*4400\*755mm  
编码: 31F006ZH-08



**FIL 风尚**  
Yonoh



编号: 31F011

框架结构: 框架为实木与多层板结构, 金属底脚 / 饰面: 主体为软包面料或皮, 底脚金属圆柱黑丝光烤漆 / 坐垫软包: 坐垫为高弹海绵复合, 最上层为蓬松棉填充 / 面料: 沙发套不可拆卸, 多种面料或牛皮可选 / 靠包: 珍珠棉和羽绒混合填充, 纯棉靠包内套, 外套为可拆卸的面料或牛皮套

STRUCTURE: Structure in solid wood and plywood, feet in metal / FINISHING: Upholstered with fabric or leather, feet in silk black lacquered metal / SEAT CUSHION: Seat cushion in high density foam polyurethane and dacron / COVERING: Non-removable covering in fabric or leather / CUSHIONS: Polyester padding and goose down with cotton pre-covering, removable covering in fabric or leather



沙发 SOFA

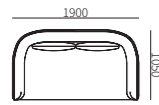

尺寸: 1900\*1050\*680mm  
编码: 31F011-12

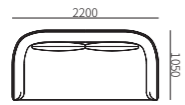

尺寸: 2200\*1050\*680mm  
编码: 31F011-13

单扶 LEFT/RIGHT ONE-ARMED SOFA

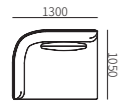

尺寸: 1300\*1050\*680mm  
编码: 31F011-20

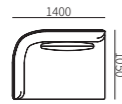

尺寸: 1400\*1050\*680mm  
编码: 31F011-21

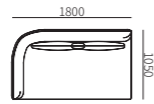

尺寸: 1800\*1050\*680mm  
编码: 31F011-22

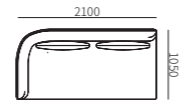

尺寸: 2100\*1050\*680mm  
编码: 31F011-23

单背 SOFA WITHOUT ARM

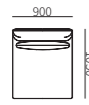

尺寸: 900\*1050\*680mm  
编码: 31F011-31

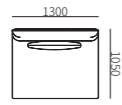

尺寸: 1300\*1050\*680mm  
编码: 31F011-32

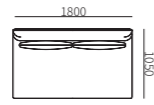

尺寸: 1800\*1050\*680mm  
编码: 31F011-33

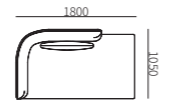

尺寸: 1800\*1050\*680mm  
编码: 31F011-41

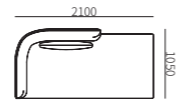

尺寸: 2100\*1050\*680mm  
编码: 31F011-42

角位 LEFT/RIGHT CORNER SEAT

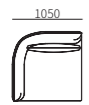

尺寸: 1050\*1050\*680mm  
编码: 31F011-61

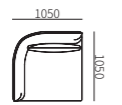

尺寸: 1050\*1050\*880mm  
编码: 31F011-62

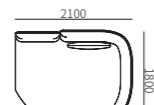

尺寸: 2100\*1800\*880mm  
编码: 31F011-63

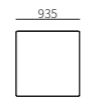

尺寸: 935\*935\*400mm  
编码: 31F011-51

墩 OTTOMAN

组合沙发 SECTIONAL SOFA

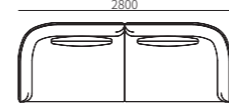

尺寸: 2800\*1050\*680mm  
编码: 31F011ZH-01

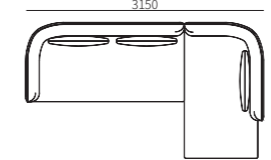

尺寸: 3150\*1800\*680mm  
编码: 31F011ZH-02

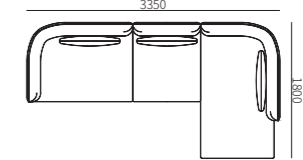

尺寸: 3350\*1800\*680mm  
编码: 31F011ZH-03

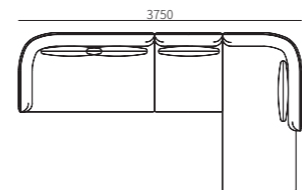

尺寸: 3750\*2100\*680mm  
编码: 31F011ZH-04

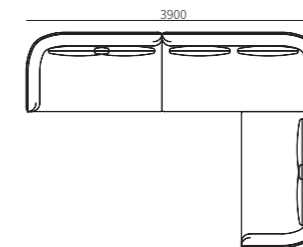

尺寸: 3900\*2850\*680mm  
编码: 31F011ZH-05

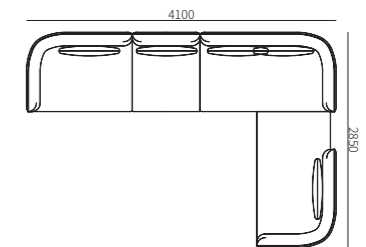

尺寸: 4100\*2850\*680mm  
编码: 31F011ZH-06

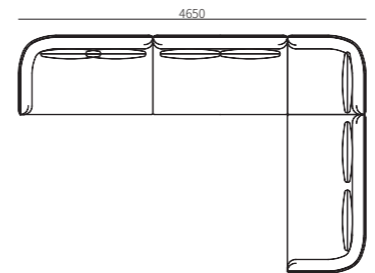

尺寸: 4650\*3150\*680mm  
编码: 31F011ZH-07

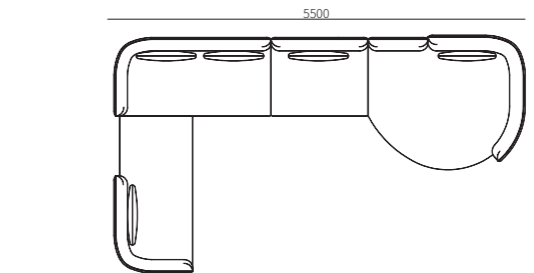

尺寸: 5500\*3150\*680mm  
编码: 31F011ZH-08

**MICHEL 米其**  
Yonoh



编号: 31F009

**框架结构:** 框架为实木与多层板结构, 金属底架 / **饰面:** 主体为软包面料或皮, 底座为金属黑色丝光烤漆 / **坐垫软包:** 坐垫为高弹海绵复合, 最上层为蓬松棉填充 / **面料:** 沙发套不可拆卸, 多种面料或牛皮可选 / **靠包:** 珍珠棉和鹅绒混合填充, 纯棉靠包内套, 外套为可拆卸的面料或牛皮套

**STRUCTURE:** Structure in solid wood and plywood, base in metal / **FINISHING:** Upholstered with fabric or leather, base in silk black lacquered metal / **SEAT CUSHION:** Seat cushion in high density foam polyurethane and dacron / **COVERING:** Non-removable covering in fabric or leather / **CUSHIONS:** Polyester padding and goose down with cotton pre-covering, removable covering in fabric or leather



沙发 SOFA

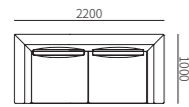

尺寸: 2200\*1000\*680mm  
编码: 31F009-13

单扶 LEFT/RIGHT ONE-ARMED SOFA

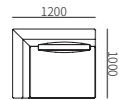

尺寸: 1200\*1000\*680mm  
编码: 31F009-21

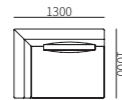

尺寸: 1300\*1000\*680mm  
编码: 31F009-20

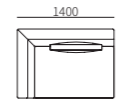

尺寸: 1400\*1000\*680mm  
编码: 31F009-22

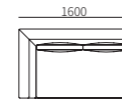

尺寸: 1600\*1000\*680mm  
编码: 31F009-23

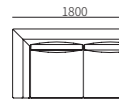

尺寸: 1800\*1000\*680mm  
编码: 31F009-24

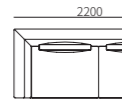

尺寸: 2200\*1000\*680mm  
编码: 31F009-25

单背 SOFA WITHOUT ARM

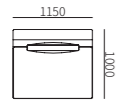

尺寸: 1150\*1000\*680mm  
编码: 31F009-31

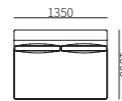

尺寸: 1350\*1000\*680mm  
编码: 31F009-32

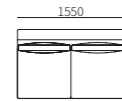

尺寸: 1550\*1000\*680mm  
编码: 31F009-33

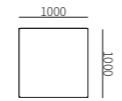

尺寸: 1000\*1000\*400mm  
编码: 31F009-51

转角 LEFT/RIGHT CHAISE

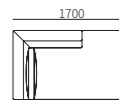

尺寸: 1700\*1000\*680mm  
编码: 31F009-41

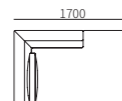

尺寸: 1700\*1200\*680mm  
编码: 31F009-42

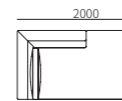

尺寸: 2000\*1000\*680mm  
编码: 31F009-43

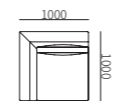

尺寸: 1000\*1000\*680mm  
编码: 31F009-44

组合沙发 SECTIONAL SOFA

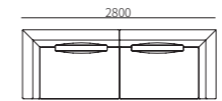

尺寸: 2800\*1000\*680mm  
编码: 31F009ZH-02

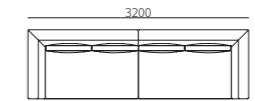

尺寸: 3200\*1000\*680mm  
编码: 31F009ZH-03

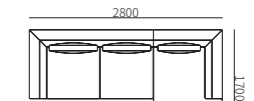

尺寸: 2800\*1700\*680mm  
编码: 31F009ZH-04

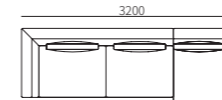

尺寸: 3200\*1700\*680mm  
编码: 31F009ZH-05

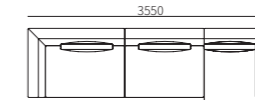

尺寸: 3550\*1700\*680mm  
编码: 31F009ZH-06

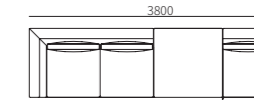

尺寸: 3800\*2600\*680mm  
编码: 更多组合

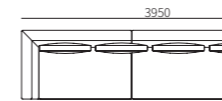

尺寸: 3950\*2000\*680mm  
编码: 31F009ZH-07

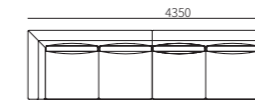

尺寸: 4350\*2700\*680mm  
编码: 31F009ZH-08

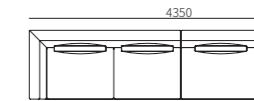

尺寸: 4350\*3000\*680mm  
编码: 31F009ZH-09

角位 LEFT/RIGHT CORNER SEAT

**EVERGREEN 常青**  
L&L Studio



编号: 31F012

框架结构: 框架为实木与多层板结构, 金属底脚 / 饰面: 主体为软包面料或皮, 底脚为黑色丝光烤漆 / 坐垫软包: 坐垫为高弹海绵复合, 最上层为蓬松棉和羽绒填充 / 面料: 沙发套不可拆卸, 多种面料或牛皮可选 / 靠包: 珍珠棉和羽绒混合填充, 纯棉靠包内套, 外套为可拆卸的面料或牛皮套

STRUCTURE: Structure in solid wood and plywood, legs in metal / FINISHING: Upholstered with fabric or leather, legs in silk black lacquered metal / SEAT CUSHION: Seat cushion in high density foam polyurethane, dacron and feather / COVERING: Non-removable covering in fabric or leather / CUSHIONS: Polyester padding and goose down with cotton pre-covering, removable covering in fabric or leather



沙发 SOFA



尺寸: 865\*900\*680mm  
编码: 31F012-11

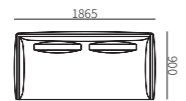

尺寸: 1865\*900\*680mm  
编码: 31F012-12

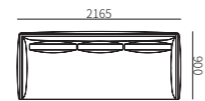

尺寸: 2165\*900\*680mm  
编码: 31F012-13

单扶 LEFT/RIGHT ONE-ARMED SOFA

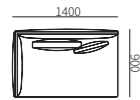

尺寸: 1400\*900\*680mm  
编码: 31F012-21

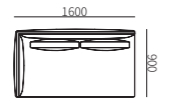

尺寸: 1600\*900\*680mm  
编码: 31F012-22

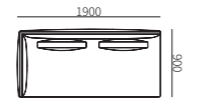

尺寸: 1900\*900\*680mm  
编码: 31F012-23

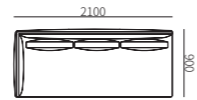

尺寸: 2100\*900\*680mm  
编码: 31F012-24

单背 SOFA WITHOUT ARM

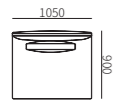

尺寸: 1050\*900\*680mm  
编码: 31F012-31

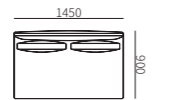

尺寸: 1450\*900\*680mm  
编码: 31F012-32

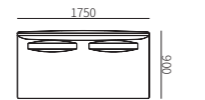

尺寸: 1750\*900\*680mm  
编码: 31F012-33

转角 LEFT/RIGHT CHAISE

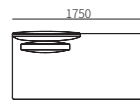

尺寸: 1750\*900\*680mm  
编码: 31F012-41

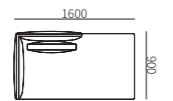

尺寸: 1600\*900\*680mm  
编码: 31F012-42

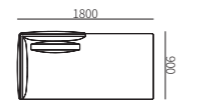

尺寸: 1800\*900\*680mm  
编码: 31F012-43

墩 OTTOMAN

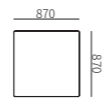

尺寸: 870\*870\*380mm  
编码: 31F012-51

组合沙发 SECTIONAL SOFA

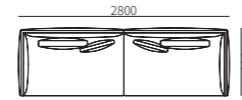

尺寸: 2800\*900\*680mm  
编码: 31F012ZH-01

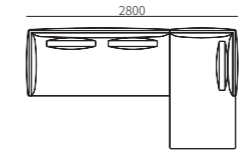

尺寸: 2800\*1600\*680mm  
编码: 31F012ZH-02

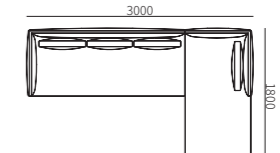

尺寸: 3000\*1800\*680mm  
编码: 31F012ZH-03

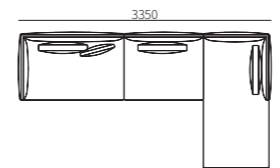

尺寸: 3350\*1800\*680mm  
编码: 31F012ZH-04

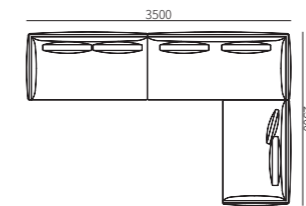

尺寸: 3500\*2300\*680mm  
编码: 31F012ZH-05

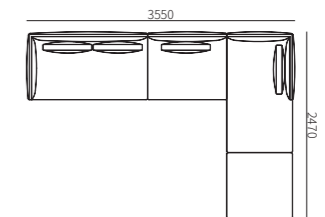

尺寸: 3550\*2470\*680mm  
编码: 31F012ZH-06

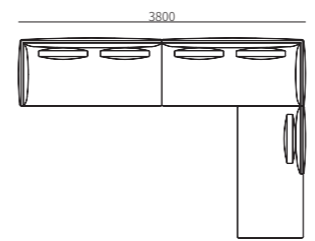

尺寸: 3800\*2650\*680mm  
编码: 31F012ZH-07

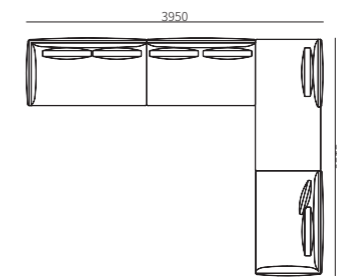

尺寸: 3950\*3150\*680mm  
编码: 31F012ZH-08

# FOLIA 红叶

Yonoh



编号: 31F007

框架结构: 框架为实木与多层板结构 / 饰面: 沙发整体为软包面料, 地脚为金属黑丝光烤漆 / 坐垫软包: 坐垫为高弹海绵复合, 最上层为蓬松棉填充 / 面料: 沙发套不可拆卸, 多种面料可选 / 靠包: 珍珠棉和鹅绒混合填充, 纯棉靠包内套, 外套为可拆卸的面料

STRUCTURE: Structure in solid wood and plywood / FINISHING: Upholstered with fabric, legs in silk black lacquered metal / SEAT CUSHION: Seat cushion in high density foam polyurethane and dacron / COVERING: Non-removable covering in fabric / CUSHIONS: Polyester padding and goose down with cotton pre-covering, removable covering in fabric

## 单扶 LEFT/RIGHT ONE-ARMED SOFA

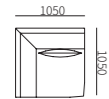

尺寸: 1050\*1050\*715mm  
编码: 31F007-21

## 单背 SOFA WITHOUT ARM

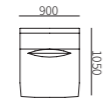

尺寸: 900\*1050\*715mm  
编码: 31F007-31

## 墩 OTTOMAN



尺寸: 900\*900\*405mm  
编码: 31F007-51

## 组合沙发 SECTIONAL SOFA

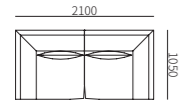

尺寸: 2100\*1050\*715mm  
编码: 31F007ZH-01

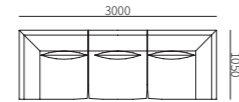

尺寸: 3000\*1050\*715mm  
编码: 31F007ZH-02

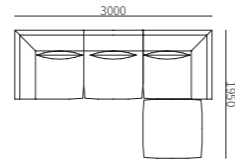

尺寸: 3000\*1950\*715mm  
编码: 31F007ZH-03

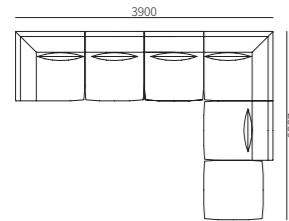

尺寸: 3900\*2850\*715mm  
编码: 31F007ZH-04

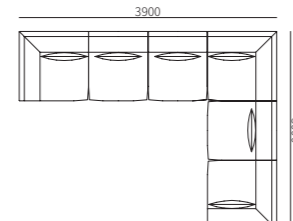

尺寸: 3900\*3000\*715mm  
编码: 31F007ZH-05

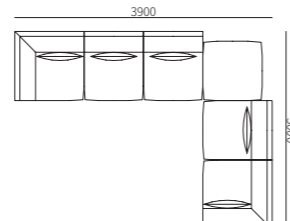

尺寸: 3900\*3000\*715mm  
编码: 31F007ZH-06

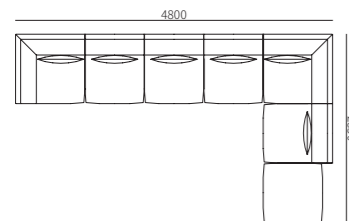

尺寸: 4800\*2850\*715mm  
编码: 31F007ZH-07



# QUADRA 嘉里

Yonoh



编号: 31F008

**框架结构:** 框架为实木与多层板结构, 不锈钢底座 / **饰面:** 主体为软包面料或皮, 底座为黑镜钛 / **坐垫软包:** 坐垫为高弹海绵复合, 最上层为蓬松棉和羽绒填充 / **面料:** 沙发套可拆卸, 多种面料或牛皮可选 / **靠包:** 珍珠棉和鹅绒混合填充, 纯棉靠包内套, 外套为可拆卸的面料或牛皮套

**STRUCTURE:** Structure in solid wood and plywood, base in stainless steel / **FINISHING:** Upholstered with fabric or leather, base in black titanium / **SEAT CUSHION:** Seat cushion in high density foam polyurethane, dacron and feather / **COVERING:** Removable covering in fabric or leather / **CUSHIONS:** Polyester padding and goose down with cotton pre-covering, removable covering in fabric or leather

## 沙发 SOFA

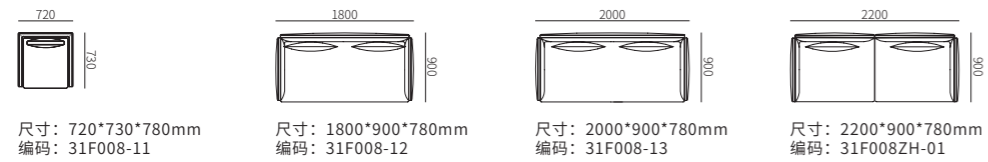

## 单扶 LEFT/RIGHT ONE-ARMED SOFA

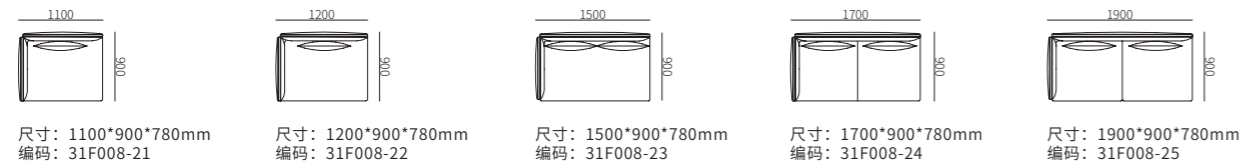

## 单背 SOFA WITHOUT ARM

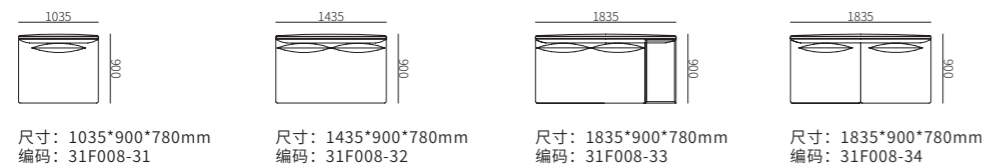

## 角位 LEFT/RIGHT CORNER SEAT

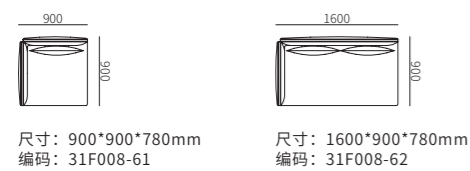

## 转角 LEFT/RIGHT CHAISE

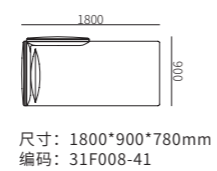

## 组合沙发 SECTIONAL SOFA

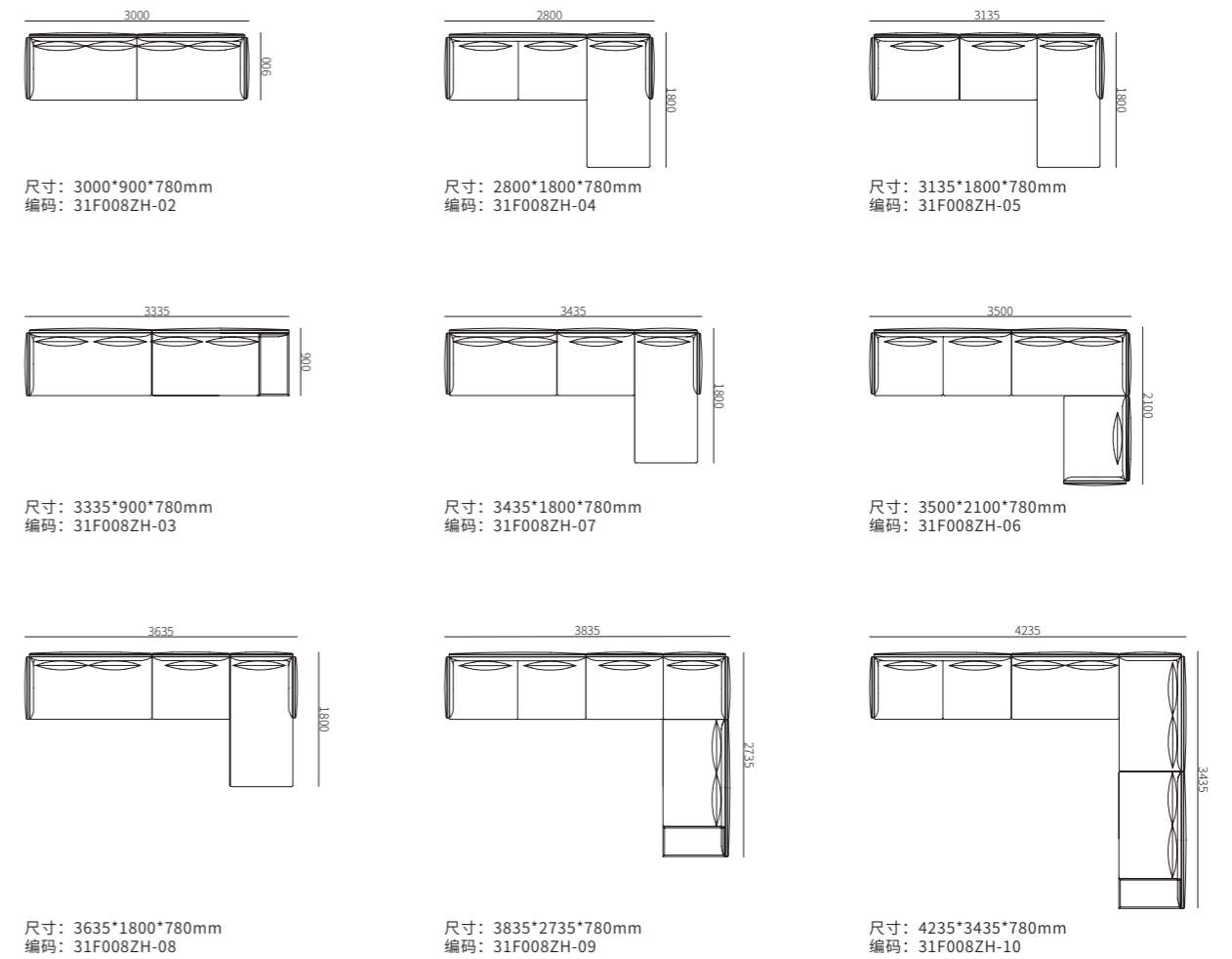

# ARMCHAIR

单人位



**CALA** 朵朵  
Yonoh



尺寸: 700\*700\*710mm  
编号: 32F004

结构: 框架为金属, PU 发泡一次成型, 座位带转盘 / 表面效果: 沙发整体为软包面料或皮 / 坐垫: 坐垫为高弹海绵复合, 上层为蓬松棉填充

STRUCTURE: Structure in metal and shaped polyurethane foam, swivel base / FINISHING: Upholstered with fabric or leather / SEAT: Seat cushion in high density foam polyurethane and dacron

**GEM** 合璧  
Sebastian Herkner

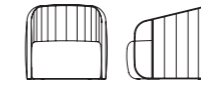

尺寸: 760\*800\*700mm  
编号: 31F018-11

结构: 框架为实木与多层板结构, 金属扶手 / 表面效果: 主体为软包面料, 扶手为不锈钢拉丝 / 坐垫: 坐垫为高弹海绵复合, 最上层为珍珠棉和羽绒混合填充

STRUCTURE: Structure in solid wood and plywood, arm in metal / FINISHING: Upholstered with fabric, armrest with brushed brass stainless steel / SEAT: Seat cushion in high density foam polyurethane and dacron

**CINI** 旖旎  
Dainelli Studio

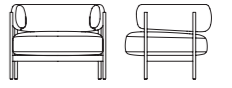

尺寸: 810\*730\*635mm  
编号: 32F012

结构: 框架为实木与多层板结构, 沙发腿为金属 / 表面效果: 主体为软包面料或皮, 底座为黑镜不锈钢镀钛或香槟金不锈钢镀钛 / 坐垫: 坐垫为高弹海绵复合, 上层为蓬松棉填充

STRUCTURE: Structure in solid wood and plywood, legs in metal / FINISHING: Upholstered with fabric or leather, legs in black or champagne titanium plating stainless steel / SEAT: Seat cushion in high density foam polyurethane and dacron

**BINZ** 宾茨  
Sebastian Herkner

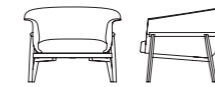

尺寸: 810\*730\*635mm  
编号: 32F013

结构: 主体为玻璃钢, 底脚为实木 / 表面效果: 主体为软包面料或牛皮, 底脚为染色橡木或者胡桃木 / 坐垫: 坐垫为高弹海绵复合, 上层为蓬松棉填充

STRUCTURE: Structure in FRP integrated molding, base in wood / FINISHING: Upholstered with fabric or leather, legs in walnut or stained oak / SEAT: Seat cushion in high density foam polyurethane and dacron

**DEBBIE** 多彼  
Dainelli Studio

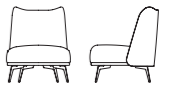

尺寸: 700\*750\*820mm  
编号: 32F011

结构: 框架为实木与多层板结构, 金属底脚 / 表面效果: 主体为软包面料或牛皮, 靠背外侧为牛皮, 底座为黑灰色氟碳漆 / 坐垫: 坐垫为高弹海绵复合, 上层为蓬松棉填充

STRUCTURE: Structure in solid wood and plywood, base in metal / FINISHING: Upholstered with fabric or leather, outside of the back in leather, base in dark grey epoxy paint / SEAT: Seat cushion in high density foam polyurethane and dacron

**GIO** 山谷  
Christophe Delcourt

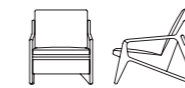

尺寸: 680\*900\*800mm  
编号: 32F002

结构: 框架为实木与多层板结构 / 表面效果: 主体为软包面料或皮, 底座为黑色亮光烤漆 / 坐垫: 坐垫为高弹海绵复合, 上层为蓬松棉填充

STRUCTURE: Structure in solid wood and plywood / FINISHING: Upholstered with fabric or leather, base in black lacquered solid wood / SEAT: Seat cushion in high density foam polyurethane and dacron

**DIAMANTE** 多德  
Archirivolto Design



尺寸: 800\*780\*800mm  
编号: 32F007

结构: 框架为实木与多层板结构, 底架为金属 / 表面效果: 主体为软包面料或皮, 底架为黑灰色氟碳漆, 金色地脚 / 坐垫: 坐垫为高弹海绵复合, 上层为蓬松棉填充

STRUCTURE: Structure in solid wood and plywood, base in metal / FINISHING: Upholstered with fabric and/or leather, base in dark grey epoxy paint, feet in gold titanium stainless steel / SEAT: Seat cushion in high density foam polyurethane and dacron

**LOVY 洛维**  
Frank Chou 周宸宸



尺寸: 640\*700\*770mm  
编号: 32F001

**结构:** 框架为金属, 主体 PU 发泡一次成型, 椅腿为金属 / **表面效果:** 主体为软包面料, 底座为金属黑丝光烤漆, 金色地脚 / **坐垫:** 坐垫为高弹海绵复合, 上层为蓬松棉填充

**STRUCTURE:** Structure in metal and shaped polyurethane foam, legs in metal / **FINISHING:** Upholstered with fabric, base in silk black lacquered metal, feet in gold titanium stainless steel / **SEAT:** Seat cushion in high density foam polyurethane and dacron

**UOVO 源**  
Steve Leung 梁志天



尺寸: 850\*850\*700mm  
编号: 32F006

**结构:** 框架为实木与多层板结构 / **表面效果:** 主体为软包面料或皮, 底座为胡桃木或染色橡木 / **坐垫:** 坐垫为高弹海绵复合, 上层为蓬松棉填充

**STRUCTURE:** Structure in solid wood and plywood / **FINISHING:** Upholstered with fabric or leather, base in walnut or stained oak / **SEAT:** Seat cushion in high density foam polyurethane and dacron

**ROUND 日月**  
Yonoh

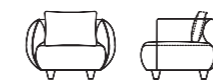

尺寸: 1020\*950\*680mm  
编号: 31F005-11

**结构:** 框架为实木与多层板结构, 木质脚 / **表面效果:** 沙发整体为软包面料或牛皮, 底脚为白色丝光或者黑色烤漆 / **坐垫:** 坐垫为高弹海绵复合, 最上层为蓬松棉填充

**STRUCTURE:** Structure in solid wood and plywood, legs in wood / **FINISHING:** Upholstered with fabric or leather, legs in silk white or black lacquer / **SEAT:** Seat cushion in high density foam polyurethane and dacron

**BOL 元阳**  
Christophe Delcourt

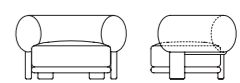

尺寸: 1020\*835\*632mm  
编号: 31F004-11

**结构:** 框架为实木与多层板结构 / **表面效果:** 主体为软包面料, 底座为胡桃木或染色橡木 / **坐垫:** 坐垫为高弹海绵复合, 上层为蓬松棉填充

**STRUCTURE:** Structure in solid wood and plywood / **FINISHING:** Upholstered with fabric, base in walnut or stained oak / **SEAT:** Seat cushion in high density foam polyurethane and dacron

**CACTUS 仙人掌**  
Archirivolto Design



尺寸: 616\*712\*720mm  
编号: 32F010

**结构:** 框架为实木与多层板结构, 不锈钢底座 / **表面效果:** 主体为软包面料或皮, 底座为不锈钢香槟金电镀 / **坐垫:** 坐垫为高弹海绵复合, 上层为蓬松棉填充

**STRUCTURE:** Structure in solid wood and plywood, legs in stainless steel / **FINISHING:** Upholstered with fabric or leather, legs in champagne titanium plating stainless steel / **SEAT:** Seat cushion in high density foam polyurethane and dacron

**CACTUS 仙人掌**  
Archirivolto Design



尺寸: 616\*712\*720mm  
编号: 32F009

**结构:** 框架为实木与多层板结构, 木质底座 / **表面效果:** 主体为软包面料或皮, 底座为胡桃或染色橡木 / **坐垫:** 坐垫为高弹海绵复合, 上层为蓬松棉填充

**STRUCTURE:** Structure in solid wood and plywood, legs in solid wood / **FINISHING:** Upholstered with fabric or leather, legs in walnut or stained oak / **SEAT:** Seat cushion in high density foam polyurethane and dacron

**HAP 哈伯**  
Christophe Delcourt



尺寸: 780\*790\*680mm  
编号: 31F013-11

**结构:** 框架为实木与多层板结构, 木质底座, 座位带转盘 / **表面效果:** 主体为软包面料或皮, 内侧和外侧的选择可不同, 底座为木质金色烤漆 / **坐垫:** 坐垫为高弹海绵复合, 上层为蓬松棉填充

**STRUCTURE:** Structure in solid wood and plywood, base in wood, swivel base / **FINISHING:** Upholstered with fabric and/or leather, and the options can be different for inside and outside of the back and arms, wood base in gold lacquer / **SEAT:** Seat cushion in high density foam polyurethane and dacron

**QUADRA 嘉里**  
Yonoh



尺寸: 720\*730\*780mm  
编号: 31F008-11

**结构:** 框架为实木与多层板结构, 底座为不锈钢 / **表面效果:** 主体为软包面料或皮, 底座为黑镜电镀不锈钢 / **坐垫:** 坐垫为高弹海绵复合, 上层为蓬松棉填充

**STRUCTURE:** Structure in solid wood and plywood, base in stainless steel / **FINISHING:** Upholstered with fabric or leather, base in black titanium plating stainless steel / **SEAT:** Seat cushion in high density foam polyurethane and dacron

**UOVO 源**  
Steve Leung 梁志天



尺寸: 620\*890\*950mm  
编号: 32F005

**结构:** 主体为玻璃钢烤漆, 底脚为实木 / **表面效果:** 主体为软包面料或皮, 外壳为黑色或白色烤漆, 底脚为胡桃木或染色橡木 / **坐垫:** 坐垫为高弹海绵复合, 上层为蓬松棉填充

**STRUCTURE:** Structure in lacquered fiberglass, legs in solid wood / **FINISHING:** Upholstered with fabric or leather, shell in white or black lacquer, legs in walnut or stained oak / **SEAT:** Seat cushion in high density foam polyurethane and dacron

**UOVO 源**  
Steve Leung 梁志天



尺寸: 1000\*1000\*755mm  
编号: 31F006-11

**结构:** 框架为实木与多层板结构, 金属脚 / **表面效果:** 主体为软包面料或皮, 底脚为黑色丝光烤漆金属 / **坐垫:** 坐垫为高弹海绵复合, 上层为蓬松棉填充

**STRUCTURE:** Structure in solid wood and plywood, feet in metal / **FINISHING:** Upholstered with fabric or leather, feet in silk black lacquered metal / **SEAT:** Seat cushion in high density foam polyurethane and dacron

# COFFEE TABLE

## 茶几



**CRI 可瑞**  
Archirivolto Design

尺寸: D1248\*335mm D1048\*335mm  
编号: 41C001

**结构:** 桌面为大理石, 框架为不锈钢 / **表面效果:** 桌面为中花白或杭灰大理石, 框架为香槟金镀钛不锈钢

**STRUCTURE:** Top in marble, stainless steel frame / **FINISHING:** Top in venato white marble or charly brown marble, base in champagne titanium plating stainless steel

**CRI 可瑞**  
Archirivolto Design



尺寸: D1248\*335mm  
D1048\*335mm  
编号: 41C002

**结构:** 桌面为实木及板材贴皮, 框架为不锈钢 / **表面效果:** 桌面为胡桃或染色橡木, 框架为香槟金镀钛不锈钢

**STRUCTURE:** Top in solid wood and veneer on particles board, stainless steel frame / **FINISHING:** Top in natural walnut or stained oak, base in champagne titanium plating stainless steel

**GRASSI 格萨**  
Sebastian Herkner



尺寸: 1200\*1200\*360mm  
1400\*600\*360mm  
830\*660\*500mm  
460\*500\*500mm  
编号: 41C023

**结构:** 桌面为钢化玻璃, 金属框架 / **表面效果:** 桌面为钢化玻璃, 底脚为香槟金镀钛或黑镜镀钛

**STRUCTURE:** Top in tempered glass, base in metal / **FINISHING:** Top in tempered glass, legs in black or champagne titanium plating stainless steel

**GRANTORINO 都灵**  
Dainelli Studio



尺寸: 1400\*1000\*320mm  
1200\*900\*320mm  
编号: 41C024 / 41C025

**结构:** 桌面为大理石或实木及刨花板贴皮, 茶几腿为金属 / **表面效果:** 桌面为中花白或者杭灰大理石或木制染色开孔漆, 茶几腿为黑灰氟碳漆

**STRUCTURE:** Top in marble or solid wood and veneer on particles board, base in metal / **FINISHING:** Top in venato white marble or charly brown marble or walnut or stained oak finishes, and base in dark grey epoxy paint

**UOVO 源**  
Steve Leung 梁志天



尺寸: 1400\*1200\*320mm  
编号: 41C010

**结构:** 桌面为大理石, 底座为实木 / **表面效果:** 桌面为中花白或杭灰大理石, 底座为胡桃木色或染色橡木

**STRUCTURE:** Top in marble, base in solid wood / **FINISHING:** Top in venato white marble or charly brown marble, base in walnut or stained oak

**CHESS 纤纤**  
L&L Studio



尺寸: D1200\*350mm  
D560\*520mm  
编号: 41C029 / 41C030

**结构:** 顶层桌面为岩板或刨花板贴皮, 顶层桌面为刨花板贴皮, 茶几腿为金属 / **表面效果:** 桌面为岩板或木制染色开孔漆, 茶几腿为香槟金镀钛或黑镜镀钛

**STRUCTURE:** Top in stone or veneer on particles board, base in veneer on particles board, frame in metal / **FINISHING:** Top in stone or walnut or stained oak, and base in black or champagne titanium plating stainless steel

**CHESS 纤纤**  
L&L Studio



尺寸: 1200\*1200\*350mm  
1400\*900\*350mm  
编号: 41C026 / 41C027

**结构:** 顶层桌面为岩板或刨花板贴皮, 顶层桌面为刨花板贴皮, 茶几腿为金属 / **表面效果:** 桌面为岩板或木制染色开孔漆, 茶几腿为香槟金镀钛或黑镜镀钛

**STRUCTURE:** Top in stone or veneer on particles board, base in veneer on particles board, frame in metal / **FINISHING:** Top in stone or walnut or stained oak, and base in black or champagne titanium plating stainless steel



**TILE 泰然**  
Yonoh



尺寸: D1200\*400mm  
编号: 41C011/41C012

**结构:** 桌面为实木及板材贴皮或大理石, 框架为金属 / **表面效果:** 桌面为胡桃木或染色橡木, 或中花白或杭灰大理石, 框架为黑灰色氟碳漆, 地脚为金色镀钛

**STRUCTURE:** Top in solid wood and veneer on particles board or marble, base in metal / **FINISHING:** Top in walnut or stained oak, or venato white marble or charly brown marble, base in dark grey epoxy paint with gold titanium feet

**GENIE 珍尼**  
L&L Studio

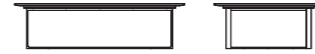

尺寸: D600\*510mm  
编号: 41C017

尺寸: 1400\*900\*382mm  
1200\*800\*382mm  
编号: 41C016

**结构:** 大理石桌面、层板实木及板材贴皮、金属下架 / **表面效果:** 方茶几桌面为中花白大理石或者杭灰大理石, 圆茶几桌面和方茶几层板胡桃木或染色橡木, 框架为灰黑色氟碳漆

**STRUCTURE:** Table top in marble, shelf in solid wood and veneer on particles board, frame in metal / **FINISHING:** Rectangular table top in venato white marble or charly brown marble, round table top and rectangular table shelf in walnut or stained oak, and base in dark grey epoxy paint

**PLAN 普兰**  
Archirivolto Design



尺寸: 1400\*1400\*373mm  
1200\*1200\*373mm  
1000\*1000\*373mm  
编号: 41C006

**结构:** 整体为实木及板材贴皮, 底座为不锈钢 / **表面效果:** 整体为胡桃木色或染色橡木, 底座为黑色镜面镀钛



尺寸: 1400\*700\*373mm  
编号: 41C006-04

**STRUCTURE:** Whole piece in solid wood and veneer on particles board, stainless steel frame / **FINISHING:** Whole piece in walnut or stained oak, base in black titanium

**FUGUE 富笛**  
Frank Chou 周宸宸

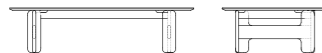

尺寸: 1400\*800\*340mm  
1200\*700\*340mm  
编号: 41C019

**结构:** 桌面为大理石, 底部为实木 / **表面效果:** 桌面为中花白或者杭灰大理石, 底部为胡桃木或者染色橡木, 或者实木黑色烤漆

**STRUCTURE:** Top in marble, base in solid wood / **FINISHING:** Top in venato white marble or charly brown marble, base in walnut or stained oak, or black lacquer solid wood

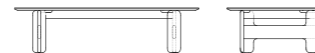

尺寸: 1400\*800\*340mm  
1200\*700\*340mm  
编号: 41C020

**结构:** 整体是实木和板材贴皮 / **表面效果:** 整体为胡桃木或者染色橡木

**STRUCTURE:** Whole piece in solid wood and veneer on particles board / **FINISHING:** Whole piece in walnut or stained oak

**ONA 融筑**  
Yonoh



尺寸: D1400\*389mm  
D1200\*389mm  
编号: 41C014

**结构:** 桌面为大理石, 层板为玻璃, 框架为金属 / **表面效果:** 桌面为中花白或者杭灰大理石, 层板为灰色钢化玻璃, 框架为黑灰色氟碳漆, 立柱上下为金色镀钛装饰

**STRUCTURE:** Top in marble, shelf in glass and base in metal / **FINISHING:** Top in venato white marble or charly brown marble, shelf in grey glass, and frame in dark grey epoxy paint with gold titanium on top and feet of posts



尺寸: D1400\*389mm  
D1200\*389mm  
编号: 41C015

**结构:** 桌面为实木及板材贴皮, 层板为玻璃, 框架为金属 / **表面效果:** 桌面为胡桃木或染色橡木, 层板为灰色钢化玻璃, 框架为黑灰色氟碳漆, 立柱上下为金色镀钛装饰

**STRUCTURE:** Top in solid wood and veneer on particles board, shelf in glass and base in metal / **FINISHING:** Top in walnut or stained oak, shelf in grey glass, and frame in dark grey epoxy paint with gold titanium on top and feet of posts

**PLAN 普兰**  
Archirivolto Design



尺寸: 1400\*1400\*373mm  
1200\*1200\*373mm  
1000\*1000\*373mm  
编号: 41C009

**结构:** 整体为实木及板材贴皮, 桌面一侧大理石, 底座为不锈钢 / **表面效果:** 整体为胡桃木色或染色橡木, 一侧桌面为中花白或杭灰大理石, 底座为黑色镜面镀钛



尺寸: 1400\*700\*373mm  
编号: 41C009-04

**STRUCTURE:** Whole piece in solid wood and veneer on particles board, one side of the top in marble, stainless steel frame / **FINISHING:** Whole piece in walnut or stained oak, one side of the top in venato white marble or charly brown marble, base in black titanium

# SIDE TABLE

## 边几



**STAGE** 云台  
Sebastian Herkner



尺寸: 360\*360\*460mm  
编号: 42C010

结构: 整体为实木 / 表面效果: 整体为胡桃木或橡木实木开孔漆

STRUCTURE: Whole piece in solid wood / FINISHING: Whole piece in walnut or stained oak

**CONE** 科恩  
Sebastian Herkner

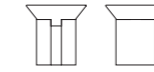

尺寸: D460\*460mm  
编号: 42C009

结构: 桌面为大理石, 底部为金属 / 表面效果: 桌面为中花白大理石, 底座为不锈钢镀铜拉丝

STRUCTURE: Top in marble, base in metal / FINISHING: Top in venato white marble, base in brushed brassy stainless steel

**ZEN** 冰心  
Hans Sandgren Jakobsen



尺寸: D354\*404mm  
编号: 42C003

结构: 整体为不锈钢 / 表面效果: 整体为黑镜镀钛或香槟金镀钛

STRUCTURE: Whole piece in stainless steel / FINISHING: Whole piece in black titanium or champagne titanium

**ENEA** 恩亚  
Archirivolto Design

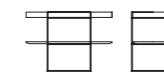

尺寸: 800\*414\*558mm  
编号: 41C028

结构: 顶层桌面为金属框架贴皮革, 次层桌面为刨花板贴皮, 茶几腿为金属 / 表面效果: 桌面为牛皮革和木制染色开孔漆, 茶几腿为黑灰色氟碳漆

STRUCTURE: Top in metal with leather and the second surface in veneer on particles board, base in metal / FINISHING: Top in leather and walnut or stained oak and base in dark grey epoxy paint

**GRANTORINO** 都灵  
Dainelli Studio



尺寸: 500\*500\*520mm  
编号: 42C007 / 42C008

结构: 桌面为大理石或刨花板贴皮, 茶几腿为金属 / 表面效果: 桌面为中花白或者杭灰大理石或木制染色开孔漆, 茶几腿为黑灰氟碳漆

STRUCTURE: Top in marble or veneer on particles board, base in metal / FINISHING: Top in venato white marble or charly brown marble, walnut or stained oak and base in dark grey epoxy paint

**OVO** 星空  
Christophe Delcourt

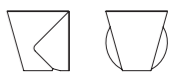

尺寸: 450\*450\*450mm  
编号: 41C007

结构: 整体玻璃钢 / 表面效果: 黑色烤漆主体, 顶圆和侧圆为杉绿色烤漆

STRUCTURE: Whole piece in fiberglass / FINISHING: Whole piece in black lacquer, except one top and one side in patina green lacquer

**LAYER** 云层  
Santiago Sevillano



尺寸: 950\*450\*530mm  
700\*475\*530mm  
编号: 41C008

结构: 桌面为大理石, 框架为不锈钢 / 表面效果: 桌面为中花白或杭灰大理石, 框架为香槟金镀钛

STRUCTURE: Top in marble, stainless steel frame / FINISHING: Top in venato white marble or charly brown marble, base in champagne titanium

**CHESS 纤纤**  
L&L Studio

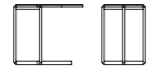

尺寸: 600\*380\*520mm  
编号: 42C011

**结构:** 顶层桌面为岩板或刨花板贴皮, 次层桌面为刨花板贴皮, 茶几腿为金属 / **表面效果:** 桌面为岩板或木制染色开孔漆, 茶几腿为香槟金镀钛或黑镜镀钛

**STRUCTURE:** Top in stone or veneer on particles board, base in veneer on particles board, frame in metal / **FINISHING:** Top in stone or walnut or stained oak, and base in black or champagne titanium plating stainless steel

**PLUS 佳怡**  
Ximi Li 李希米

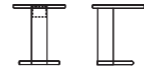

尺寸: D470\*560mm  
编号: 42C005

**结构:** 整体为实木和板材贴皮, 底座是不锈钢 / **表面效果:** 整体为胡桃木或者染色橡木, 底座为香槟金镀钛

**STRUCTURE:** Whole piece in solid wood and veneer on particles board, except base in stainless steel / **FINISHING:** Whole piece in walnut or stained oak, except base in champagne titanium

**ONA 融筑**  
Yonoh



尺寸: D600\*488mm  
D480\*488mm  
编号: 41C014 / 41C015

**结构:** 桌面为大理石或实木及板材贴皮, 层板为玻璃, 框架为金属 / **表面效果:** 桌面为中花白或杭灰大理石, 或胡桃木或染色橡木, 层板为灰色钢化玻璃, 框架为黑灰色氟碳漆, 立柱上下为金色镀钛装饰

**STRUCTURE:** Top in marble, or solid wood and veneer on particles board, shelf in glass and base in metal / **FINISHING:** Top in venato white marble or charly brown marble, or walnut or stained oak, shelf in grey glass, and frame in dark grey epoxy paint with gold titanium on top and feet of posts

**FUGUE 富笛**  
Frank Chou 周宸宸



尺寸: D480\*480mm  
编号: 41C022 / 41C021

**结构:** 桌面为实木和板材贴皮或大理石, 底部为实木 / **表面效果:** 桌面为胡桃木或染色橡木, 或者杭灰或中花白大理石, 底部为胡桃木或染色橡木, 或者实木黑色烤漆

**STRUCTURE:** Top in marble or solid wood and veneer on particles board, base in solid wood / **FINISHING:** When top in venato white marble or charly brown marble, base in walnut or stained oak, or black lacquer; or whole piece in walnut or stained oak

**CRI 可瑞**  
Archirivolto Design



尺寸: D648\*449mm  
编号: 41C001-03

**结构:** 桌面为大理石, 框架为不锈钢 / **表面效果:** 桌面为中花白或杭灰大理石, 框架为香槟金镀钛不锈钢

**STRUCTURE:** Top in marble, stainless steel frame / **FINISHING:** Top in venato white marble or charly brown marble, base in champagne titanium plating stainless steel



尺寸: D648\*449mm  
编号: 41C002-03

**结构:** 桌面为实木及板材贴皮, 框架为不锈钢 / **表面效果:** 桌面为胡桃木或染色橡木, 框架为香槟金镀钛不锈钢

**STRUCTURE:** Top in solid wood and veneer on particles board, stainless steel frame / **FINISHING:** Top in walnut or stained oak, base in champagne titanium plating stainless steel

**FAN 融筑**  
Frank Chou 周宸宸



尺寸: 470\*260\*555mm  
编号: 42C006

**结构:** 桌面为大理石, 框架为不锈钢 / **表面效果:** 桌面为中花白大理石, 框架为黄铜色镀钛

**STRUCTURE:** Top in marble, stainless steel frame / **FINISHING:** Top in venato white marble, base in brassy titanium

**UOVO 源**  
Steve Leung 梁志天

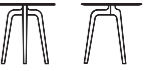

尺寸: D600\*600mm  
编号: 42C004

**结构:** 桌面为玻璃, 底座是实木 / **表面效果:** 桌面是灰色玻璃, 底座为胡桃木或染色橡木

**STRUCTURE:** Top in glass and base in solid wood / **FINISHING:** Top in grey glass, and base in walnut or staine oak

**TILE 泰然**  
Yonoh

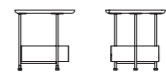

尺寸: D500\*500mm  
编号: 41C012

**结构:** 桌面为实木及板材贴皮, 框架为金属 / **表面效果:** 桌面为胡桃木或染色橡木, 框架为黑灰色氟碳漆, 地脚为金色镀钛

**STRUCTURE:** Top in solid wood and veneer on particles board, base in metal / **FINISHING:** Top in walnut or stained oak, base in dark grey epoxy paint with gold titanium feet



尺寸: D500\*500mm  
编号: 41C011

**结构:** 桌面为大理石, 框架为金属 / **表面效果:** 桌面为中花白或杭灰大理石, 框架为黑灰色氟碳漆, 地脚为金色镀钛

**STRUCTURE:** Top in marble, base in metal / **FINISHING:** Top in venato white marble or charly brown marble, base in dark grey epoxy paint with gold titanium feet

**COSMO 星际**  
Masayuki Kurokawa 黒川雅之



尺寸: 400\*400\*400mm  
编号: 71C001

**结构:** 整体金属 / **表面效果:** 整体黑镜镀钛或者香槟金镀钛

**STRUCTURE:** Whole piece in stainless steel / **FINISHING:** Whole piece in black titanium or champagne titanium

# CONSOLE 条案

## GRANTORINO 都灵

Dainelli Studio

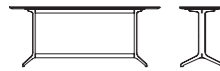

尺寸: 1800\*450\*500mm  
1500\*450\*500mm  
编号: 43C004 / 43C005

**结构:** 桌面为大理石或实木及刨花板贴皮, 茶几腿为金属 / **表面效果:** 桌面为中花白或者杭灰大理石或木制染色开孔漆, 茶几腿为黑灰氟碳漆

**STRUCTURE:** Top in marble or solid wood and veneer on particles board, base in metal / **FINISHING:** Top in venato white marble or charly brown marble or walnut or stained oak finishes, and base in dark grey epoxy paint

## LONJA 龙佳

Santiago Sevillano



尺寸: 1500\*382\*570mm  
1200\*382\*570mm  
编号: 43C001

**结构:** 台面为实木及板材贴皮, 框架为不锈钢 / **表面效果:** 桌子为胡桃或染色橡木, 底架为香槟金镀钛

**STRUCTURE:** Table in solid wood and veneer on particles board, and frame in stainless steel / **FINISHING:** Table in walnut or stained oak, base in champagne titanium

## MOON 尚月

L&L Studio

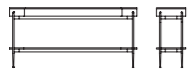

尺寸: 1800\*420\*850mm  
1500\*420\*850mm  
1200\*420\*850mm  
编号: 13C003

**结构:** 桌面为密度板贴皮, 框架为不锈钢 / **表面效果:** 桌子为胡桃木或染色橡木, 底架为香槟金镀钛或黑镜镀钛

**STRUCTURE:** Top in veneer on MDF board and frame in stainless steel / **FINISHING:** Table in walnut or stained oak, base in black or champagne titanium

## MOON 尚月

L&L Studio

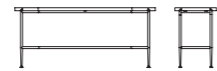

尺寸: 1600\*420\*600mm  
1400\*420\*600mm  
1200\*420\*600mm  
编号: 43C003

**结构:** 桌面为密度板贴皮, 嵌入岩板, 框架为不锈钢 / **表面效果:** 桌子为胡桃木或染色橡木以及黑白根或鱼肚白岩板, 底架为香槟金镀钛或黑镜镀钛

**STRUCTURE:** Table in veneer on MDF board with stone, and frame in stainless steel / **FINISHING:** Table in walnut or stained oak with stone available in Nero Marquina or Calacatta White, base in black or champagne titanium plating stainless steel

## VIVI 微微

L&L Studio

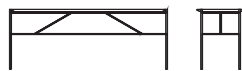

尺寸: 1500\*450\*570mm  
1200\*450\*570mm  
编号: 43C002

**结构:** 台面为烤漆密度板, 框架为不锈钢 / **表面效果:** 桌面为烤漆, 底架为香槟金镀钛

**STRUCTURE:** Table in lacquered MDF, and frame in stainless steel / **FINISHING:** Top in lacquer, frame in champagne titanium

## LARGO 罗曼

P&P Studio

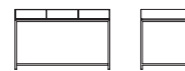

尺寸: 1800\*400\*850mm  
1500\*400\*850mm  
编号: 13C001

**结构:** 主体为板材贴皮, 框架为不锈钢 / **表面效果:** 主体为胡桃或染色橡木, 框架为黑镜镀钛

**STRUCTURE:** Structure in veneer on particles board, stainless steel frame / **FINISHING:** Structure in walnut or stained oak, frame in black titanium

# LIVING CABINET 电视柜

## 电视柜



## RHYTHM 半岛 L&L Studio



带背板 WITH BACK PANELS

尺寸: 4800\*472\*1664mm 4200\*472\*1664mm  
3600\*472\*1664mm 3300\*472\*1664mm  
3000\*472\*1664mm 2700\*472\*1664mm  
编号: 52C004



不带背板 WITHOUT BACK PANELS

尺寸: 4200\*472\*528mm 3600\*472\*528mm  
3300\*472\*528mm 3000\*472\*528mm  
2700\*472\*528mm 2400\*472\*528mm  
1800\*472\*528mm

**结构:** 主体为板材贴皮, 金属层板, 底柜顶面为大理石, 门板和抽屉面烤漆 / **表面效果:** 柜体和背板为胡桃或染色橡木, 背板铝合金黑丝光烤漆封边, 金属黑丝光烤漆层板, 底柜台面为中花白或者杭灰大理石, 底柜门板和抽屉面为烤漆

**STRUCTURE:** Structure in veneer on particles board, shelf in metal, top of bottom cabinet in marble, doors and drawer fronts in lacquered MDF / **FINISHING:** Structure and back panel in walnut or stained oak, edging in silk black lacquered aluminum alloy, shelf in silk black metal. Top of the bottom cabinet in venato white marble or charly brown marble, all doors and drawer fronts in lacquer

**RHYTHM 半岛**  
L&L Studio



尺寸: 1200\*500\*465mm  
900\*500\*465mm  
编号: 52C009

结构: 主体为刨花板贴皮, 金属底脚 / 表面效果: 主体为胡桃木或染色橡木, 底脚为黑灰色氟碳漆

STRUCTURE: Structure in veneer on particles board, base in metal / FINISHING: Structure in walnut or stained oak, base in dark grey epoxy paint

**STRATA 斯巴达**  
Studio Roderick Vos

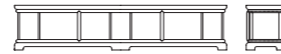

尺寸: 3206\*450\*512mm  
2806\*450\*512mm  
2406\*450\*512mm  
2006\*450\*512mm  
1806\*450\*512mm  
编号: 52C008

结构: 主体为密度板 / 表面效果: 整体为烤漆, 颜色可选

STRUCTURE: Structure in MDF / FINISHING: Whole piece in different color lacquer

**GRU 律动**  
Christophe Delcourt



尺寸: 3000\*480\*600mm  
2400\*480\*600mm  
1800\*480\*600mm  
编号: 52C003

结构: 主体为板材贴皮, 把手和底座为金属 / 表面效果: 主体为胡桃或染色橡木, 把手和底座为岩绿色烤漆

STRUCTURE: Structure in veneer on particles board, handles and base in metal / FINISHING: Structure in walnut or stained oak, handles and base in black green lacquered metal

**LARGO 罗曼**  
L&L Studio

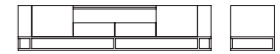

尺寸: 2358\*490\*500mm  
2138\*490\*500mm  
1860\*490\*500mm  
编号: 52C006

结构: 主体为刨花板贴皮, 烤漆内盒, 金属底架 / 表面效果: 柜体外侧为胡桃或染色橡木, 开放储物格为酒红色烤漆, 底架为黑镜镀铬

STRUCTURE: Structure in veneer on particles board, base in metal / FINISHING: Structure in walnut or stained oak, open storage in BORDEAUX RED lacquer, metal base in black titanium plating stainless steel

**LONJA 龙佳**  
Santiago Sevillano

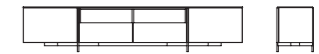

尺寸: 2400\*400\*500mm  
2000\*400\*500mm  
编号: 52C001

结构: 主体为板材贴皮, 顶面为大理石, 底座为不锈钢 / 表面效果: 主体为胡桃或染色橡木, 顶面为中花白或杭灰大理石, 底架为香槟金镀铬

STRUCTURE: Structure in veneer on particles board, top in marble, stainless steel frame / FINISHING: Structure in walnut or stained oak, top in venato white marble or charly brown marble, base in champagne titanium

# DINING TABLE

## 餐桌



**GAUDI 高迪**  
Achirivolto Design

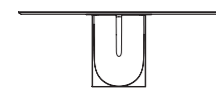

尺寸: D2200\*750mm  
D2000\*750mm  
D1800\*750mm  
D1600\*750mm  
编号: 11C019

**结构:** 桌面为刨花板贴皮, 实木封边, 配大理石或密度板烤漆转盘, 底座为镜面不锈钢 / **表面效果:** 桌面为胡桃或染色橡木, 搭配中华白大理石或杭灰大理石转盘或烤漆, 镜面不锈钢底座

**STRUCTURE:** Top in veneer on particles board, solid wood edging with marble or lacquered MDF turnplate, base in mirror stainless steel / **FINISHING:** Top in walnut or stained oak with venato white marble or charly brown marble or lacquered turnplate, base in mirror stainless steel

## REMBRANT 玲珑

Archirivolto Design



尺寸: 2400\*1100\*750mm  
2200\*1100\*750mm  
2000\*1100\*750mm  
1800\*1000\*750mm  
1600\*1000\*750mm  
编号: 11C013



**结构:** 桌面为大理石, 不锈钢底架 / **表面效果:** 桌面中花白大理石或杭灰大理石, 香槟金镀钛钢架或黑灰色氟碳漆金属底架

**STRUCTURE:** Top in marble and frame in stainless steel / **FINISHING:** Top in venato white marble or charly brown marble, frame in champagne titanium plating stainless steel, or dark grey epoxy paint

## MIAMI 迈阿密

Archirivolto Design



尺寸: D1800\*750mm  
D1600\*750mm  
D1400\*750mm  
编号: 11C003 / 11C004



**结构:** 桌面为大理石, 或实木及板材贴皮, 底座为不锈钢与大理石 / **表面效果:** 桌面可为中花白大理石、杭灰大理石、胡桃或染色橡木, 底座为香槟金镀钛。当桌面为大理石时, 底座大理石与桌面同色; 当桌面为木质时, 底座为中花白大理石

**STRUCTURE:** Top in marble or solid wood and veneer on particles board, base in stainless steel and marble / **FINISHING:** Top in venato white marble or charly brown marble, walnut or stained oak. Frame in champagne titanium. When top is in marble, the marble on the base is the same with the one on the top. And when top is in wood, the marble on the base can only be in venato white marble

## FUGUE 富笛

Frank Chou 周宸宸



尺寸: 2400\*1000\*750mm  
2200\*1000\*750mm  
2000\*1000\*750mm  
1800\*900\*750mm  
1600\*900\*750mm  
编号: 11C017



**结构:** 桌面为大理石, 底架为实木 / **表面效果:** 桌面为中花白或者杭灰大理石, 桌腿为胡桃木或染色橡木, 或黑色烤漆实木腿

**STRUCTURE:** Top in marble and base in solid wood / **FINISHING:** Top in venato white marble or charly brown marble, frame in walnut or stained oak, or black lacquered solid wood

## SIFF 江月

Christophe Delcourt

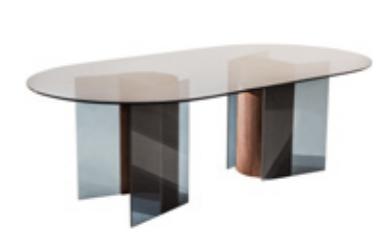

尺寸: 2300\*1100\*740mm  
2000\*1100\*740mm  
1800\*1100\*740mm  
1600\*1100\*740mm  
编号: 11C001



**结构:** 桌面为钢化玻璃, 底座为玻璃和板材贴皮 / **表面效果:** 桌面为浅灰色玻璃, 底座为灰色玻璃和胡桃木色或染色橡木

**STRUCTURE:** Top in glass, base in glass and veneer on particles board / **FINISHING:** Top in gray glass, base in gray glass and walnut or stained oak

## UOVO 源

Steve Leung 梁志天



尺寸: D1800\*750mm  
D1600\*750mm  
D1400\*750mm  
编号: 11C005



**结构:** 桌面为实木及板材贴皮, 桌腿为实木, 转盘为木质烤漆、大理石或毛毡饰面 / **表面效果:** 桌面和桌腿为胡桃或染色橡木, 转盘为木质烤漆、中花白或杭灰大理石

**STRUCTURE:** Whole piece in solid wood and veneer on particles board, legs in solid wood, and turnplate in lacquer, marble or linoleum / **FINISHING:** Whole piece in walnut or stained oak, except turnplate in lacquer, venato white marble or charly brown marble



尺寸: 2400\*1000\*750mm  
2200\*1000\*750mm  
2000\*1000\*750mm  
1800\*900\*750mm  
1600\*900\*750mm  
编号: 11C018



**结构:** 桌面为实木及板材贴皮, 实木开孔漆腿 / **表面效果:** 整体为胡桃木或染色橡木

**STRUCTURE:** Whole piece in solid wood and veneer on particles board / **FINISHING:** Whole piece in walnut or stained oak

## FLU 芙蓉

Achirivolto Design



尺寸: 2400\*1100\*750mm  
2200\*1100\*750mm  
2000\*1100\*750mm  
1800\*1000\*750mm  
1600\*1000\*750mm  
编号: 11C015



结构: 桌面为实木及板材贴皮, 实木腿 / 表面效果: 桌面为胡桃木或染色橡木, 烤漆实木腿

STRUCTURE: Top in solid wood and veneer on particles board, and legs in solid wood / FINISHING: Top in walnut or stained oak, legs in lacquered solid wood



尺寸: 2400\*1100\*750mm  
2200\*1100\*750mm  
2000\*1100\*750mm  
1800\*1000\*750mm  
1600\*1000\*750mm  
编号: 11C014



结构: 桌面为大理石, 实木腿 / 表面效果: 桌面中花白大理石或杭灰大理石、实木腿烤漆

STRUCTURE: Top in marble, and legs in solid wood / FINISHING: Top in venato white marble or charly brown marble, legs in lacquered solid wood

## FIKA 贝加

Frank Chou 周宸宸



尺寸: 2440\*1140\*750mm  
2240\*1140\*750mm  
2040\*1140\*750mm  
1840\*1040\*750mm  
1640\*940\*750mm  
编号: 11C016



结构: 桌面为板材贴皮, 桌腿为实木 / 表面效果: 整体为胡桃或染色橡木色橡木

STRUCTURE: Top in veneer on particles board, legs in solid wood / FINISHING: Whole piece in walnut or stained oak

## CHAIR

### 椅子



## CHIP 齐贝 Yonoh



尺寸: 539\*525\*772mm  
编号: 21F010

结构: 框架为金属, 主体PU发泡一次成型, 椅腿为金属 / 表面效果: 软包不可拆卸, 多种面料或牛皮可选, 椅腿为黑灰色氟碳漆, 金色地脚

STRUCTURE: Structure in metal and shaped polyurethane foam, legs in metal / FINISHING: Upholstered with non-removable covering in fabric or leather, legs in dark grey epoxy paint, feet in gold titanium stainless steel,

## LIME 琳云

Archirivolto Design



尺寸: 455\*575\*850mm  
编号: 21F009

**结构:** 主体为多层板, 椅腿为金属 / **表面效果:** 软包不可拆卸, 多种面料或牛皮可选, 椅腿为黑灰色氟碳漆

**STRUCTURE:** Structure in plywood, legs in metal / **FINISHING:** Upholstered with non-removable covering in fabric or leather, legs in dark grey epoxy paint

## ENCONTRA 轻舟

L&L Studio



尺寸: 500\*590\*850mm  
编号: 21F005

**结构:** 主体为多层板, 椅腿为实木 / **表面效果:** 软包不可拆卸, 多种面料或牛皮可选, 椅腿为胡桃木或染色橡木

**STRUCTURE:** Structure in plywood, legs in solid wood / **FINISHING:** Upholstered with non-removable covering in fabric or leather, legs in walnut or stained oak

## TONO 合生

Yonoh



尺寸: 600\*570\*770mm  
编号: 21F004

**结构:** 主体为多层板, 椅腿为实木 / **表面效果:** 软包不可拆卸, 多种面料或牛皮可选, 椅腿为胡桃木或染色橡木

**STRUCTURE:** Structure in plywood, legs in solid wood / **FINISHING:** Upholstered with non-removable covering in fabric or leather, legs in walnut or stained oak

## BOLA 飞燕

Yonoh



尺寸: 600\*560\*775mm  
编号: 21F003

**结构:** 主体为多层板, 椅腿为金属 / **表面效果:** 软包不可拆卸, 多种面料或牛皮可选, 椅腿为金属黑色丝光烤漆, 金色地脚

**STRUCTURE:** Structure in plywood, legs in metal / **FINISHING:** Upholstered with non-removable covering in fabric, metal legs in silk black lacquered metal, feet in gold titanium stainless steel

## NAO 尼奥

Archirivolto Design



尺寸: 446\*568\*890mm  
编号: 21F012

**结构:** 主体为弯曲木及多层板, 椅腿为实木 / **表面效果:** 椅腿为胡桃或染色橡木, 软包不可拆卸, 多种面料或牛皮可选

**STRUCTURE:** Structure in plywood, legs in solid wood / **FINISHING:** Legs in walnut or stained oak, upholstered with non-removable covering in fabric or leather

## NAO 尼奥

Archirivolto Design



尺寸: 446\*568\*810mm  
编号: 21F008

**结构:** 主体为多层板, 椅腿为实木 / **表面效果:** 软包不可拆卸, 多种面料或牛皮可选, 椅腿为胡桃或染色橡木

**STRUCTURE:** Structure in plywood, legs in solid wood / **FINISHING:** Upholstered with non-removable covering in fabric or leather, legs in walnut or stained oak

## OHO 燕亭

Christophe Delcourt



尺寸: 500\*580\*800mm  
编号: 21F001

**结构:** 主体为多层板, 椅腿为实木 / **表面效果:** 软包不可拆卸, 多种面料或牛皮可选, 椅腿为胡桃或染色橡木

**STRUCTURE:** Structure in plywood, legs in solid wood / **FINISHING:** Upholstered with non-removable covering in fabric or leather, legs in walnut or stained oak

## UOVO 源

Steve Leung 梁志天

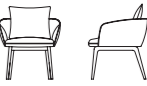

尺寸: 660\*630\*650mm  
编号: 22F001

**结构:** 主体为多层板, 椅腿为实木 / **表面效果:** 软包不可拆卸, 多种面料或牛皮可选, 椅腿为胡桃或染色橡木

**STRUCTURE:** Structure in plywood, legs in solid wood / **FINISHING:** Upholstered with non-removable covering in fabric or leather, legs in walnut or stained oak

## HOME 依恋

Yonoh



尺寸: 485\*575\*783mm  
编号: 21F002

**结构:** 主体为多层板, 椅腿为金属 / **表面效果:** 软包不可拆卸, 多种面料可选, 面料软包配黑色滚边线, 椅腿为金属黑色丝光烤漆, 金色地脚

**STRUCTURE:** Structure in plywood, legs in metal / **FINISHING:** Upholstered with non-removable covering in fabric, matching with black piping line, legs in silk black lacquered metal, feet in gold titanium stainless steel

## MONCLER 羽容

Archirivolto Design



尺寸: 457\*562\*850mm  
编号: 21F007

**结构:** 主体为多层板, 椅腿为金属 / **表面效果:** 软包不可拆卸, 多种面料或牛皮可选, 椅腿为黑灰色氟碳漆

**STRUCTURE:** Structure in plywood, legs in metal / **FINISHING:** Upholstered with non-removable covering in fabric or leather, legs in dark grey epoxy paint

## HELLO 哈罗

L&L Studio



尺寸: 485\*495\*1000mm  
485\*495\*900mm  
编号: 24F001

**结构:** 主体为弯曲木及多层板, 椅腿为金属 / **表面效果:** 主体为软包牛皮或面料, 底座为黑镜或香槟金镀钛不锈钢

**STRUCTURE:** Structure in plywood, legs in metal / **FINISHING:** Upholstered with fabric or leather, legs in black or champagne titanium plating stainless steel



**PRISMA 万象**  
Studio Roderick Vos

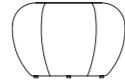

尺寸: 1000\*866\*400mm  
800\*693\*400mm  
600\*519\*400mm  
500\*433\*450mm  
编号: 23F004

结构: 多层板框架, 金属底脚 / 表面效果: 主体为软包面料  
STRUCTURE: Structure in plywood, legs in stainless steel / FINISHING: Upholstered with fabric

**PULO 布丁**  
Archirivolto Design

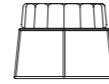

尺寸: D600\*450mm  
D500\*500mm  
编号: 23F001

结构: 主体为多层板, 底架为金属 / 表面效果: 软包不可拆卸, 多种面料或牛皮可选, 底脚为金属黑丝光烤漆或香槟金电镀  
STRUCTURE: Structure in plywood, base in metal / FINISHING: Upholstered with non-removable covering in fabric or leather, base in silk black lacquered metal or champagne titanium

**LONJA 龙佳**  
Santiago Sevillano

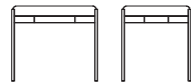

尺寸: 516\*416\*450mm  
编号: 23F002

结构: 主体为多层板, 不锈钢框架 / 表面效果: 主体为软包面料或皮, 底座为不锈钢香槟金电镀  
STRUCTURE: Structure in plywood, legs in stainless steel / FINISHING: Upholstered with fabric or leather, base in champagne titanium plating stainless steel

**SIDEBOARD**

餐边柜



**STRATA 斯巴达**  
Studio Roderick Vos

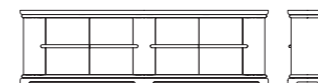

尺寸: 3206\*450\*852mm  
2806\*450\*852mm  
2406\*450\*852mm  
2006\*450\*852mm  
1806\*450\*852mm  
编号: 51C011

结构: 主体为密度板 / 表面效果: 整体为烤漆, 颜色可选

STRUCTURE: Structure in MDF / FINISHING: Whole piece in different color lacquer

**GRU 律动**  
Christophe Delcourt

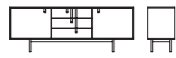

尺寸: 2100\*480\*800mm  
1800\*480\*800mm  
编号: 51C002

**结构:** 主体为板材贴皮, 把手和底座为金属 / **表面效果:** 主体为胡桃或染色橡木, 把手和底座为金属岩绿烤漆

**STRUCTURE:** Structure in veneer on particles board, handles and base in metal / **FINISHING:** Structure in walnut or stained oak, handles and base in black green lacquered metal

**RITA 瑞达**  
L&L Studio

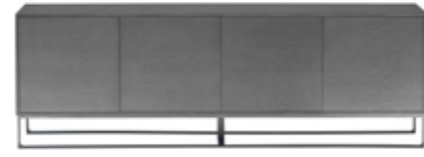

尺寸: 2400\*500\*800mm  
2000\*500\*800mm  
1800\*500\*800mm  
编号: 51C009

**结构:** 主体为板材贴皮, 金属底架 / **表面效果:** 柜体外侧为胡桃或染色橡木, 内侧为白橡, 底架为灰黑色氟碳漆

**STRUCTURE:** Structure in veneer on particles board, base in metal / **FINISHING:** Structure in walnut or stained oak, inner panels in white oak, metal base in dark grey epoxy paint

**LARGO 罗曼**  
P&P Studio



尺寸: 2000\*500\*750mm  
1800\*500\*750mm  
1500\*500\*750mm  
编号: 51C004

**结构:** 主体为板材贴皮, 底座为不锈钢 / **表面效果:** 主体为胡桃或染色橡木, 底架为黑镜镀铬

**STRUCTURE:** Structure in veneer on particles board, base in stainless steel / **FINISHING:** Structure in walnut or stained oak, base in black titanium

**RITA 瑞达**  
L&L Studio



尺寸: 1200\*454\*1500mm  
编号: 51C010

**结构:** 主体为板材贴皮, 金属底架 / **表面效果:** 柜体为胡桃或染色橡木, 上层开放部分带有烤漆内盒和镜子, 金属黑灰氟碳漆底架

**STRUCTURE:** Structure in veneer on particles board, base in metal / **FINISHING:** Structure in walnut or stained oak, and lacquered tray and mirror included in the top opening, metal base in dark grey epoxy paint

**GRAPHIC 平川**  
P&P Studio

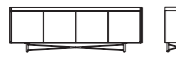

尺寸: 2158\*450\*800mm  
1858\*450\*800mm  
编号: 51C005

**结构:** 主体为板材贴皮, 门板为烤漆, 底座为金属 / **表面效果:** 主体为胡桃或染色橡木, 门板为条纹岩绿烤漆, 底座为金属黑丝光烤漆

**STRUCTURE:** Structure in veneer on particles board, doors in lacquered MDF, base in metal / **FINISHING:** Structure in walnut or stained oak, doors in striped black green lacquer, base in silk black lacquered metal

**GRAPHIC 平川**  
P&P Studio

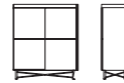

尺寸: 1106\*450\*1255mm  
编号: 51C006

**结构:** 主体为板材贴皮, 门板为烤漆, 底座为金属 / **表面效果:** 主体为胡桃或染色橡木, 门板为条纹岩绿烤漆, 底座为金属黑丝光烤漆

**STRUCTURE:** Structure in veneer on particles board, doors in lacquered MDF, base in metal / **FINISHING:** Structure in walnut or stained oak, doors in striped black green lacquer, base in silk black lacquered metal

**LONJA 龙佳**  
Santiago Sevillano

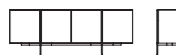

尺寸: 2200\*450\*800mm  
2000\*450\*800mm  
编号: 51C001

**结构:** 主体为板材贴皮, 顶面为大理石, 框架为不锈钢 / **表面效果:** 主体为胡桃或染色橡木, 顶面为中花白或杭灰大理石, 底架为香槟金镀铬

**STRUCTURE:** Structure in veneer on particles board, top in marble, stainless steel frame / **FINISHING:** Structure in walnut or stained oak, top in venato white marble or charly brown marble, base in champagne titanium

**LONJA 龙佳**  
Santiago Sevillano

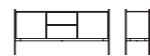

尺寸: 2200\*466\*862mm  
1800\*466\*862mm  
1600\*466\*862mm  
编号: 51C003

**结构:** 主体为板材贴皮, 顶面为大理石, 框架为不锈钢 / **表面效果:** 主体为胡桃或染色橡木, 顶面为中花白或杭灰大理石, 底架为香槟金镀铬

**STRUCTURE:** Structure in veneer on particles board, top in marble, stainless steel frame / **FINISHING:** Structure in walnut or stained oak, top in venato white marble or charly brown marble, base in champagne titanium

# BED & BEDSIDE TABLE

## 床 & 床头柜



**BARRY** 百瑞  
Ximi Li 李希米

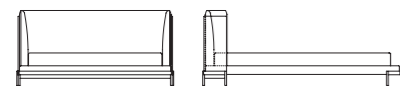

尺寸: 2325\*2293\*875mm (床垫 2000\*2000mm)    2125\*2293\*875mm (床垫 1800\*2000mm)  
1925\*2293\*875mm (床垫 1600\*2000mm)    1825\*2293\*875mm (床垫 1500\*2000mm)  
编号: 61F010

床头: 外包围为牛皮, 内布软包为面料或牛皮 / 结构: 框架为实木与多层板结构, 黑灰氟碳漆金属腿

HEADBOARD: Inside upholstered with fabric or leather, and outside with leather /  
STRUCTURE: Structure in solid wood and plywood, legs in dark grey epoxy paint

## UOVO 源

Steve Leung 梁志天



尺寸: 2550\*2285\*1080mm (床垫 2000\*2000mm)  
2350\*2285\*1080mm (床垫 1800\*2000mm)  
2150\*2285\*1080mm (床垫 1600\*2000mm)  
2050\*2285\*1080mm (床垫 1500\*2000mm)  
编号: 61F002

床头: 面料或牛皮软包床头 / 结构: 框架为实木与多层板结构, 底脚为实木开孔漆

HEADBOARD: Upholstered with fabric or leather / STRUCTURE: Structure in solid wood and plywood, feet in walnut or stained oak

## CITTI 西提

Frank Chou 周宸宸

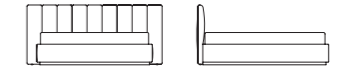

尺寸: 2250\*2175\*1000mm (床垫 2000\*2000mm)  
2250\*2175\*1000mm (床垫 1800\*2000mm)  
2000\*2175\*1000mm (床垫 1600\*2000mm)  
2000\*2175\*1000mm (床垫 1500\*2000mm)  
1500\*2175\*1000mm (床垫 1200\*2000mm)  
编号: 61F001

床头: 面料或牛皮软包床头 / 结构: 框架为实木与多层板结构, 气动床箱, 床围底座木质金色烤漆

HEADBOARD: Upholstered with fabric or leather / STRUCTURE: Structure in solid wood and plywood, pneumatic trunk-bed, wood base in gold lacquer

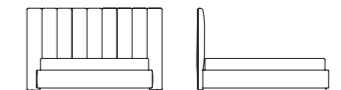

尺寸: 2500\*2175\*1300mm (床垫 2000\*2000mm)  
2250\*2175\*1300mm (床垫 1800\*2000mm)  
2000\*2175\*1300mm (床垫 1600\*2000mm)  
2000\*2175\*1300mm (床垫 1500\*2000mm)  
1500\*2175\*1300mm (床垫 1200\*2000mm)  
编号: 61F007

床头: 面料或牛皮软包床头 / 结构: 框架为实木与多层板结构, 气动床箱, 床围底座木质金色烤漆

HEADBOARD: Upholstered with fabric or leather / STRUCTURE: Structure in solid wood and plywood, pneumatic trunk-bed, wood base in gold lacquer

**HAP 哈伯**  
Christophe Delcourt



尺寸: 2200\*2184\*1080mm (床垫 2000\*2000mm)  
2000\*2184\*1080mm (床垫 1800\*2000mm)  
1800\*2184\*1080mm (床垫 1600\*2000mm)  
1700\*2184\*1080mm (床垫 1500\*2000mm)  
编号: 61F005

床头: 面料或牛皮软包床头, 内侧和外侧的选择可不同 / 结构: 框架为实木与多层板结构, 床围底座木质金色烤漆

HEADBOARD: Upholstered with fabric or leather and the options can be different for inside and outside of the headboard / STRUCTURE: Structure in solid wood and plywood, wood base in gold lacquer

**LONJA 龙佳**  
Santiago Sevillano



带床尾板 WITH FOOTBOARD  
尺寸: 2210\*2270\*1100mm (床垫 2000\*2000mm)  
2010\*2270\*1100mm (床垫 1800\*2000mm)  
1810\*2270\*1100mm (床垫 1600\*2000mm)  
1710\*2270\*1100mm (床垫 1500\*2000mm)  
编号: 61F003



无床尾板 WITHOUT FOOTBOARD  
编号: 61F008

床头: 面料或牛皮软包床头 / 结构: 底脚为金色镀钛不锈钢, 框架为实木与多层板结构

HEADBOARD: Upholstered with fabric or leather / STRUCTURE: Structure in solid wood and plywood, legs in champagne titanium plating stainless steel

**FUGUE 富笛**  
Frank Chou 周宸宸



尺寸: 2320\*2260\*1150mm (床垫 2000\*2000mm)  
2120\*2260\*1150mm (床垫 1800\*2000mm)  
1920\*2260\*1150mm (床垫 1600\*2000mm)  
1820\*2260\*1150mm (床垫 1500\*2000mm)  
编号: 61F006

床头: 面料或牛皮软包床头 / 结构: 框架为实木与多层板结构, 金属黑丝光烤漆腿

HEADBOARD: Upholstered with fabric or leather / STRUCTURE: Structure in solid wood and plywood, legs in silk black lacquered metal

**HOOP 霍普**  
L&L Studio



尺寸: 560\*420\*540mm  
编号: 53C010

结构: 主体为弯曲木贴皮, 立腿为金属 / 表面效果: 主体为胡桃或染色橡木, 立腿为黑灰色氟碳漆金属

STRUCTURE: Structure in veneer on plywood board, and frame in metal / FINISHING: Structure in walnut or stained oak, frame in dark grey epoxy paint

**GRU 律动**  
Christophe Delcourt

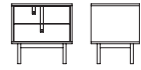

尺寸: 700\*480\*600mm  
600\*480\*600mm  
编号: 53C003

结构: 主体为实木及板材贴皮, 拉手及底架为金属 / 表面效果: 主体为胡桃或染色橡木, 把手及底架为岩绿色金属烤漆

STRUCTURE: Whole piece in solid wood and veneer on particles board, handles and base in metal / FINISHING: Structure in walnut or stained oak, handles and base in black green lacquered metal

**ANNI 悠然**  
L&L Studio

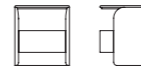

尺寸: D500\*550mm  
编号: 53C002

结构: 框架为弯曲木贴皮, 顶部和抽屉面为烤漆密度板 / 表面效果: 框架为胡桃或染色橡木, 顶部和抽屉面为烤漆

STRUCTURE: Structure in veneer on bent wood, top and drawer front in lacquered MDF / FINISHING: Structure in walnut or stained oak, top and drawer front in lacquer

**LONJA 龙佳**  
Santiago Sevillano



尺寸: 516\*466\*540mm  
编号: 53C004 / 53C005

结构: 主体为板材贴皮, 抽屉面为板材贴皮或烤漆密度板, 框架不锈钢 / 表面效果: 主体为胡桃木或染色橡木, 抽屉面为胡桃木或染色橡木或烤漆, 框架为香槟金镀钛

STRUCTURE: Structure in veneer on particles board, drawer fronts in veneer on particles board or MDF, frame in stainless steel / FINISHING: Structure in walnut or stained oak, drawer fronts in walnut or stained oak, or in lacquer, and frame in champagne titanium

**RITA 瑞达**  
L&L Studio

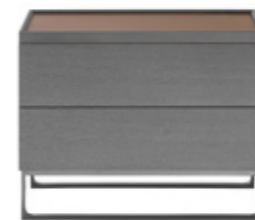

尺寸: 700\*480\*500mm  
600\*480\*500mm  
编号: 53C007

结构: 主体板材贴皮, 顶面实木围边, 底架金属 / 表面效果: 整体为胡桃或染色橡木, 顶面嵌入超纤皮, 底架黑灰色氟碳漆

STRUCTURE: Structure in veneer on particles board, top edging in solid wood, and frame in metal / FINISHING: Structure and top edging in walnut or stained oak, top covered with Microfiber PU leather and frame in dark grey epoxy paint

**BELLA 贝拉**  
L&L Studio



尺寸: 700\*495\*500mm  
编号: 53C008

结构: 整体板材贴皮 / 表面效果: 整体为胡桃木或染色橡木, 顶面为超纤皮, 产品圆角分左右, 图片中的为左

STRUCTURE: Whole piece in veneer on particles board / FINISHING: Whole piece in walnut or stained oak, and top in Microfiber PU leather. Rounded corner on left or right side, the one in the picture is on the left

**LARGO 罗曼**  
L&L Studio

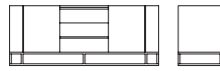

尺寸: 2138\*490\*670mm  
1860\*490\*670mm  
1660\*490\*670mm  
编号: 52C007

**结构:** 主体为刨花板贴皮, 烤漆内盒, 金属底架 / **表面效果:** 柜体外侧为胡桃或染色橡木, 开放储物格为酒红色烤漆, 底架为黑镜镀钛

**STRUCTURE:** Structure in veneer on particles board, base in metal / **FINISHING:** Structure in walnut or stained oak, open storage in BORDEAUX RED lacquer, metal base in black titanium plating stainless steel

**BELLA 贝拉**  
L&L Studio

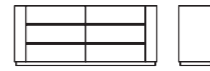

尺寸: 1906\*450\*800mm  
1506\*450\*800mm  
编号: 52C005

**结构:** 主体为板材贴皮 / **表面效果:** 整体胡桃木或者染色橡木, 面板贴超纤皮, 六个抽屉

**STRUCTURE:** Whole piece in veneer on particles board / **FINISHING:** Whole piece in walnut or stained oak, top of the cabinet in Microfiber PU leather, totally six drawers

**BARRY 百瑞**  
Ximi Li 李希米

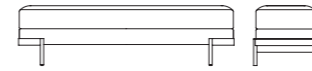

尺寸: 1810\*485\*450mm  
1610\*485\*450mm  
编号: 24F003

**结构:** 主体为多层板及实木结构, 底脚为金属 / **表面效果:** 主体为软包面料或牛皮, 底座为黑灰氟碳漆

**STRUCTURE:** Structure in solid wood and plywood, legs in stainless steel / **FINISHING:** Upholstered with fabric or leather, legs in dark grey epoxy paint

**CITTI 西提**  
L&L Studio

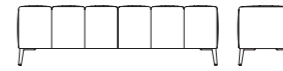

尺寸: 1750\*420\*450mm  
1500\*420\*450mm  
编号: 24F002

**结构:** 主体为多层板及实木结构, 底脚为金属 / **表面效果:** 主体为软包面料或牛皮, 底座为黑色丝光烤漆

**STRUCTURE:** Structure in solid wood and plywood, legs in stainless steel / **FINISHING:** Upholstered with fabric or leather, legs in silk black lacquered metal

**LONJA 龙佳**  
Santiago Sevillano



尺寸: 1300\*450\*1270mm  
编号: 14C002

**结构:** 主体为板材贴皮, 框架为不锈钢 / **表面效果:** 桌子为胡桃或染色橡木, 底架和镜框为香槟金镀钛

**STRUCTURE:** Table in veneer on particles board, base and mirror frame in stainless steel / **FINISHING:** Table in walnut or stained oak, base and mirror frame in champagne titanium

**LARGO 罗曼**  
P&P Studio



尺寸: 1200\*450\*1270mm  
尺寸: 1000\*450\*1270mm  
编号: 14C001

**结构:** 主体和镜面为板材贴皮, 框架为不锈钢 / **表面效果:** 主体和镜框为胡桃或染色橡木, 框架为黑镜镀钛

**STRUCTURE:** Structure in veneer on particles board, base in stainless steel / **FINISHING:** Mirror frame and table top in walnut or stained oak, base in black titanium

**LONJA 龙佳**  
Santiago Sevillano

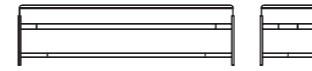

尺寸: 1816\*416\*450mm  
1616\*416\*450mm  
编号: 24F001

**结构:** 主体为多层板, 不锈钢框架 / **表面效果:** 主体为软包面料或牛皮, 底座为不锈钢香槟金镀钛

**STRUCTURE:** Structure in plywood, legs in stainless steel / **FINISHING:** Upholstered with fabric or leather, base in champagne titanium plating stainless steel

**PLUS 佳怡**  
Ximi Li 李希米



尺寸: 480\*470\*1270mm  
编号: 53C006

**结构:** 整体为实木及板材贴皮, 框架为不锈钢 / **表面效果:** 整体为胡桃或染色橡木, 框架为黑镜镀钛或香槟金镀钛

**STRUCTURE:** Whole piece in solid wood and veneer on particles board, except frame in stainless steel / **FINISHING:** Whole piece in walnut or stained oak, frame in black or champagne titanium

**LONJA 龙佳**  
Santiago Sevillano



尺寸: 1184\*414\*1820mm  
编号: 56C001

**结构:** 整体框架和底层层板为香槟金镀钛不锈钢, 中间条几为胡桃木或者染色橡木, 包含软包面料或皮质坐垫。左侧中花白大理石托盘, 右侧挂镜香槟金镀钛不锈钢镶边 / **表面效果:** 整体框架和底层层板为香槟金镀钛不锈钢, 中间条几为胡桃木或者染色橡木, 包含软包面料或皮质坐垫。左侧中花白大理石托盘, 下方另有胡桃木或染色橡木储物盒, 右侧挂镜香槟金镀钛不锈钢镶边。

**STRUCTURE:** Whole frame and bottom shelf in champagne titanium, bench in walnut or stained oak with seat cushion in fabric or leather, tray on the left in venato white marble, and hanging mirror with champagne titanium frame / **FINISHING:** Whole frame and bottom shelf in champagne titanium, bench in walnut or stained oak with seat cushion in fabric or leather, tray in venato white marble, wood box underneath in walnut or stained oak, and hanging mirror with champagne titanium frame

# DESK & BOOKCASE

## 书桌 & 书架



**STRATA** 斯巴达  
Studio Roderick Vos

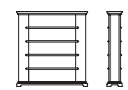

尺寸: 1760\*400\*1871mm  
1760\*400\*1529mm  
1560\*400\*1871mm  
1560\*400\*1529mm  
编号: 55C003

结构: 主体为密度板 / 表面效果: 整体为烤漆, 颜色可选

STRUCTURE: Structure in MDF / FINISHING: Whole piece in different color lacquer

## UO 优沃

Hi Thanks Bye



尺寸: 610\*619\*1788mm  
编号: 71C008

结构: 搁架前板和背板为烤漆密度板, 中层置物架和框架为金属 / 表面效果: 整体岩绿色烤漆

STRUCTURE: Front and back panels are lacquered MDF, shelf and base in metal / FINISHING: Whole piece in dark green lacquer

## RHYTHM 半岛

L&L Studio

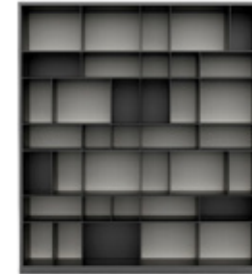

组合尺寸: 2374\*357\*2697mm  
3526\*357\*2697mm  
4390\*357\*2697mm

2374\*357\*2401mm  
3526\*357\*2401mm  
4390\*357\*2401mm

2374\*357\*1975mm  
3526\*357\*1975mm  
4390\*357\*1975mm  
更多尺寸详见官网

编号: 55C002

结构: 整体为实木和密度板 / 表面效果: 整体为烤漆, 除背板为白色哑光烤漆

STRUCTURE: Whole piece in solid wood and MDF / FINISHING: Whole piece in lacquer, except back panel in matt white lacquer

## LARGO 罗曼

P&P Studio

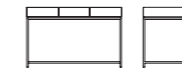

尺寸: 1600\*600\*760mm  
1400\*600\*760mm  
1200\*600\*760mm  
编号: 12C001

结构: 主体为板材贴皮, 框架为不锈钢 / 表面效果: 主体为胡桃或染色橡木, 框架为黑镜钛

STRUCTURE: Structure in veneer on particles board, stainless steel frame / FINISHING: Structure in walnut or stained oak, frame in black titanium

## ACCESSORY 配饰

### ILLUSION 叠影 MARIO TSAI 蔡烈超



尺寸: 450\*450\*1500mm  
编号: 72C001

表面效果: 整体香槟金镀钛不锈钢  
FINISHING: Whole piece in champagne titanium plating stainless steel

### COSMO 星际 Masayuki Kurokawa 黑川雅之



尺寸: 40\*40\*40mm  
编号: 71C007

表面效果: 整体黄铜拉丝或者透明亚克力  
FINISHING: Whole piece in brushed brass or clear acrylic

### FLYING MIRROR 飞镜 MARIO TSAI 蔡烈超



尺寸: 600\*400\*50mm  
编号: 71C003

表面效果: 镜面和香槟金镀钛不锈钢  
FINISHING: Mirror with champagne titanium plating stainless steel



尺寸: 500\*550\*50mm  
编号: 71C004

表面效果: 镜面和香槟金镀钛不锈钢  
FINISHING: Mirror with champagne titanium plating stainless steel

## RUG 地毯

### CORNICE 漫步 Studio Roderick Vos



尺寸: 4500\*3442mm  
4000\*3060mm  
3500\*2612mm  
3200\*2326mm  
编号: DCA99

表面效果: 新西兰羊毛加丝  
FINISHING: New Zealand wool with silk

### HALO 追光者 Studio Roderick Vos

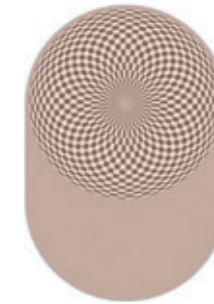

尺寸: 4500\*3000mm  
4000\*2667mm  
3500\*2334mm  
3200\*2134mm  
编号: DCA100

表面效果: 100% 新西兰羊毛  
FINISHING: 100% New Zealand wool

### TUMBLE 探帛 Studio Roderick Vos



尺寸: 4500\*3015mm  
4000\*2670mm  
3500\*2345mm  
3200\*2144mm  
编号: DCA101

表面效果: 100% 新西兰羊毛  
FINISHING: 100% New Zealand wool

电话 / 010-85262862-828  
传真 / 010-85262780  
2020年8月出版印刷，版权所有，侵权必究  
hc28.com.cn

T/ +86-10-85262862-828  
F/ +86-10-85262780  
PRINTED: AUGUST 2020 COPYRIGHT HC28 COSMO ALL RIGHTS RESERVED,  
ANY REPRODUCTION, REPRESENTATION OR MODIFICATION, IN FULL OR  
PARTLY, IS EXPRESSLY PROHIBITED.  
hc28.com.cn